



Sigma 4-5KRL

from serial no. 165039



Refrigerated Centrifuge
for Robot Use

Operating Manual

part no. 0703302



© Copyright by
Sigma Laborzentrifugen GmbH
An der Unteren Söse 50
37520 Osterode am Harz
Germany

Tel.: +49 (0) 5522 / 5007-0
Fax: +49 (0) 5522 / 5007-12
Internet: www.sigma-zentrifugen.de
E-Mail: info@sigma-zentrifugen.de

1	General information	9
1.1	Importance of the operating manual	9
1.2	Intended use	9
1.3	Warranty and liability	9
1.4	Copyright	10
1.5	Standards and regulations	10
1.6	Scope of supply	10
2	Layout and mode of operation	11
2.1	Layout of the centrifuge	11
2.1.1	Functional and operating elements	11
2.1.2	Name plate	13
2.1.3	Serial interface (pin assignment)	14
2.2	Mode of operation	15
2.2.1	Centrifugation principle	15
2.2.2	Area of application	15
2.2.2.1	Speed, radius, and relative centrifugal force	16
2.2.2.2	Density	16
3	Safety	17
3.1	Marking of the unit	17
3.2	Explanation of the symbols and notes	18
3.3	Responsibility of the operator	19
3.4	Operating personnel	19
3.5	Informal safety instructions	19
3.6	Safety instructions	20
3.6.1	Electrical safety	20
3.6.2	Mechanical safety	20
3.6.3	Safety Instructions for robot-controlled centrifuges	21
3.6.4	Fire prevention	21
3.6.5	Chemical and biological safety	21
3.6.6	Safety instructions for centrifugation	22
3.6.7	Resistance of plastics	22
3.6.8	Safety of rotors and accessories	23
3.6.8.1	Service life	23
3.7	Safety devices	24
3.7.1	Lid lock device	24
3.7.2	Standstill monitoring system	24
3.7.3	System check	24
3.7.4	Earth conductor check	24
3.7.5	Imbalance monitoring system	24
3.7.6	Temperature monitoring system	24
3.7.7	Rotor monitoring system	24
3.8	Measures in the event of hazards and accidents	25
3.9	Remaining hazards	25

Inhaltsverzeichnis

4	Storage and transport	26
4.1	Dimensions and weight.....	26
4.2	Storage conditions	26
4.3	Notes on transport	26
4.4	Packaging.....	27
4.5	Transport safety device.....	27
5	Set-up and connection	28
5.1	Installation site	28
5.2	Power supply	28
5.2.1	Type of connection	28
5.2.2	Customer-provided fuses.....	29
6	Using the centrifuge	30
6.1	Initial start-up	30
6.2	Switching the centrifuge on	30
6.2.1	Opening and closing the lid.....	30
6.2.2	Installation of rotors and accessories	31
6.2.2.1	Installation of the rotor.....	31
6.2.2.2	Installation of accessories	31
6.2.2.3	Adapters	33
6.2.2.4	Vessels	33
6.3	Control system "Spincontrol L"	34
6.3.1	User interface	34
6.3.2	Manual mode.....	35
6.3.2.1	Starting a centrifugation run	35
6.3.2.2	Interrupting a centrifugation run	35
6.3.2.3	Interrupting a deceleration process	35
6.3.2.4	Selection, display, and modification of data.....	35
6.3.2.1	Speed / relative centrifugal force (RCF)	36
6.3.2.2	Runtime	36
6.3.2.3	Temperature	38
6.3.2.4	Rotor selection.....	40
6.3.2.5	Acceleration and deceleration curves.....	41
6.3.2.6	Program lock ("ProgLock")	41
6.3.2.7	Cycle display ("Cycles")	42
6.3.2.8	Input lock	43
6.3.3	Program mode.....	43
6.3.3.1	Saving a program.....	44
6.3.3.2	Loading a program.....	44
6.4	Use as a robot-controlled centrifuge	45
6.4.1	Connection	45
6.4.2	Rotors.....	45
6.4.3	Input	46
6.4.3.1	Positioning of the rotor	46
6.5	Switching the centrifuge off	47

7	Malfunctions and error correction	48
7.1	General malfunctions	48
7.1.1	Emergency lid release	49
7.2	Table of error codes.....	50
7.3	Service contact	51
8	Maintenance and service	52
8.1	Maintenance	52
8.1.1	Centrifuge	52
8.1.1.1	Condenser (only refrigerated centrifuges with an air-cooled refrigeration system)	53
8.1.2	Accessories	53
8.1.2.1	Plastic accessories	54
8.1.3	Rotors, buckets and carriers	54
8.1.4	Load bearing bolts	55
8.1.5	Glass breakage	56
8.2	Sterilisation and disinfection of the rotor chamber and accessories	56
8.2.1	Autoclaving	57
8.3	Service	58
8.4	Return of defective centrifuges or parts	59
9	Disposal	61
9.1	Disposal of the centrifuge	61
9.2	Disposal of the packaging.....	61
10	Technical data	62
10.1	Ambient conditions	63
10.2	Technical documentation	63
11	Appendix	64
11.1	Suitable accessories.....	64
11.1.1	Rotor radii.....	64
11.2	Speed-gravitational-field-diagram	65
11.3	Acceleration and deceleration curves	66
11.4	Table of the service life of rotors and accessories.....	67
11.5	Resistance data	68
11.6	Serial Control Interface Specification	73
11.7	EC declaration of conformity	99
11.8	Declaration of conformity – China RoHS 2.....	103
12	Index	105

Inhaltsverzeichnis

1 General information

1.1 Importance of the operating manual

A fundamental requirement for the safe and trouble-free operation of the centrifuge is to be familiar with the fundamental safety instructions and all possible hazards.

The operating manual includes important information concerning the safe operation of the centrifuge.

This operating manual and, in particular, the notes on safety and hazards must be observed by all persons operating the centrifuge.

In addition, the local rules and regulations for the prevention of accidents must be complied with.

1.2 Intended use

The laboratory centrifuge is suitable for the separation of constituents of different densities in mixtures with a maximum density of 1.2 g/cm³.

The laboratory centrifuge that is marked with IVD is intended for human biological samples, including donated blood and tissue, in conjunction with diagnostic in-vitro applications. This means that it is a medical product in accordance with the IVD directive 98/79/EC.

Only trained, specialised personnel are authorised to use the centrifuge in closed laboratories.

The intended use also includes:

- observation of all of the notes and instructions that are included in the operating manual and
- compliance with the inspection and maintenance instructions.

Sigma Laborzentrifugen GmbH cannot be held liable for any damage resulting from non-compliance.

1.3 Warranty and liability

The warranty and liability are subject to our "General Conditions" that were distributed to the operator upon the conclusion of the contract.

Warranty and liability claims are excluded if they are due to:

- improper use.
- non-compliance with the safety instructions and hazard warnings in the operating manual.
- improper installation, start-up, operation, or maintenance of the centrifuge.

1 General information

1.4 Copyright

The copyright concerning the operating manual remains with Sigma Laborzentrifugen GmbH.

The operating manual is solely intended for the operator and their personnel. It includes instructions and information that must not be

- duplicated,
- distributed, or
- communicated in any other way.

Non-compliance may be prosecuted under criminal law.

1.5 Standards and regulations

EC declaration of conformity
(see chapter 11.7 - "EC declaration of conformity")

1.6 Scope of supply

The centrifuge comprises:

- | | |
|--|------------------|
| • 1 rotor wrench, size 13 | Part no. 930 102 |
| • 1 hexagon socket wrench size 5 | Part no. 930 051 |
| • 1 tube of silicone grease | Part no. 984 780 |
| • 1 tube (30 g) heavy-duty grease for load-bearing bolts | Part no. 71 401 |
| • 1 RS232 cable | Part no. 246 135 |

Documentation:

Operating manual incl. EC declaration of conformity
(see chapter 11.7 - "EC declaration of conformity")

Accessories

According to your order, our order confirmation, and your delivery note.

2 Layout and mode of operation

2.1 Layout of the centrifuge

2.1.1 Functional and operating elements

- 1 Centrifuge lid
- 2 User interface
(see chapter 6.3.1 -
"User interface")
- 3 Slide cover
- 4 Mains switch



Fig. 1: Total view of the centrifuge

- 5 Name plate
(see chapter 2.1.2 -
"Name plate")



Fig. 2: Rear view of the centrifuge

2 Layout and mode of operation

- 6 Serial interface
(see chapter 2.1.3 -
"Serial interface (pin
assignment)")
- 7 Equipotential bonding
screw
- 8 Fuse
- 9 Mains power input

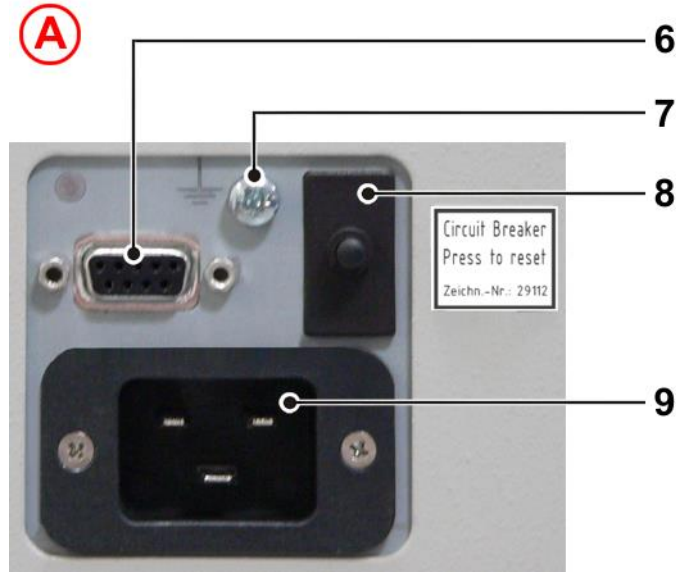

Fig. 3: Detailed view A - connections

2 Layout and mode of operation

2.1.2 Name plate

- 1 Manufacturer
- 2 Power consumption
- 3 Max. speed
- 4 Max. kinetic energy
- 5 Serial number
- 6 Part number
- 7 Type
- 8 Nominal voltage
- 9 CE mark in compliance with the directive 2006/42/EC
- 10 Symbol for special disposal (see chapter 9 - "Disposal")
- 11 Consult operating manual
- 12 Date of manufacture
- 13 IVD mark (if applicable)
- 14 Max. permissible density
- 15 Refrigerant data

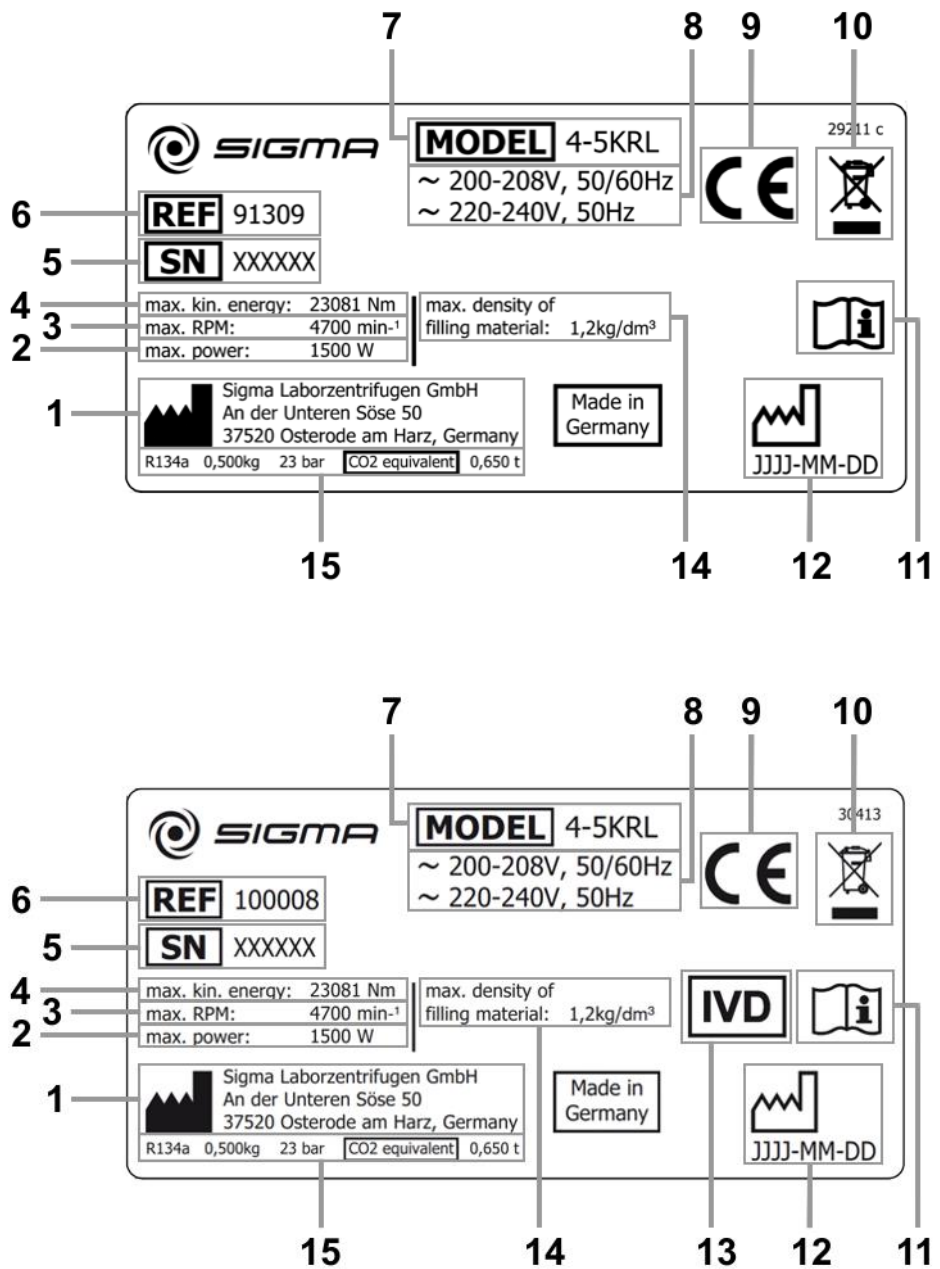

Fig. 4: Example of a name plate

2 Layout and mode of operation

2.1.3 Serial interface (pin assignment)

There is a floating, normally closed contact between pin 1 and pin 4. When the centrifuge is started, the contact opens, thereby signalling that the centrifuge is ready for operation.

The switching capacity is 48 VDC/1 A maximum.

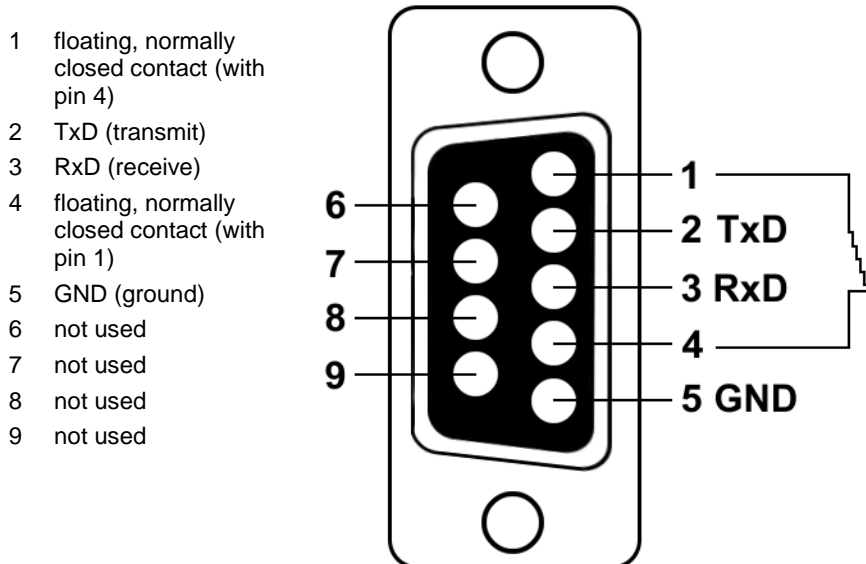

Fig. 5: Pin assignment of the serial interface

2.2 Mode of operation

2.2.1 Centrifugation principle

Centrifugation is a process for the separation of heterogeneous mixtures of substances (suspensions, emulsions, or gas mixtures) into their components. The mixture of substances, which rotates on a circular path, is subject to centripetal acceleration that is several times greater than the gravitational acceleration.

Centrifuges use the mass inertia inside the rotor chamber for separating the substances. Due to their higher inertia, particles or media with a higher density travel outwards. In doing so, they displace the components with a lower density, which in turn travel towards the centre.

The centripetal acceleration of an object inside a centrifuge, as the effect of centripetal force, depends on the distance between the object and the axis of rotation as well as on the angular velocity. It increases linearly as a function of the distance with regard to the axis of rotation and quadratically as a function of the angular velocity. The bigger the radius in the rotor chamber is and the higher the speed is, the higher the centripetal acceleration is. However, the forces acting on the rotor also increase.

2.2.2 Area of application

Depending on the area of application of the centrifuge and also on the particle size, solids content, and volume throughput of the mixture of substances that is to be centrifuged, there are different types of centrifuges.

The areas of application go from household use as a salad spinner or honey separator up to specialised technical applications in the clinical, biological, or biochemical context:

- For numerous clinical examinations, cellular material must be separated from the liquid to be analysed. The normal separation process can be sped up considerably by using laboratory centrifuges.
- In the metal-working industry, centrifuges are used for separating oil from metal cuttings. Dairies use centrifuges in order to separate cow's milk into cream and low-fat milk.
- Particularly big centrifuges are used in the sugar industry for separating the syrup from the crystalline sugar.
- Ultracentrifuges are predominantly used in biology and biochemistry in order to isolate particles, e.g. viruses. They are specifically designed for high speeds up to 500,000 rpm. The rotor moves in a vacuum in order to avoid air friction.

2 Layout and mode of operation

2.2.2.1 Speed, radius, and relative centrifugal force

The acceleration g , which the samples are subject to, can be increased by increasing the radius in the rotor chamber and by increasing the speed. These three parameters are interdependent and linked with each other via the following formula:

$$\text{Relative centrifugal force RCF} = 11.18 \times 10^{-6} \times r \times n^2$$

r = radius in cm

n = speed in rpm

RCF without any dimension

If two values are entered, the third value is determined by way of the stated formula. If, afterwards, the speed or the radius is changed, the resulting relative centrifugal force will be recalculated automatically by the control unit. If the RCF is changed, the speed will be adapted while the specified radius is maintained.

The speed-gravitational-field-diagram provides an overview of the relationship between speed, radius, and RCF (see chapter 11.2 - "Speed-gravitational-field-diagram").

2.2.2.2 Density

The laboratory centrifuge is suitable for the separation of constituents of different densities in mixtures with a maximum density of 1.2 g/cm^3 . All information concerning the speed of rotors and accessories refers to liquids with a density corresponding to this specification. If the density is above this value, the maximum permissible speed of the centrifuge must be reduced based on the following formula:













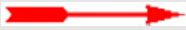

$$n = n_{max} \times \sqrt{(1,2 / Rho)}$$

Rho = density in g/cm^3

3 Safety

3.1 Marking of the unit

The following symbols are used for this type of centrifuge:

	General danger		On (Power)
	Risk of bruising		Off (Power)
	Protective earth (ground)		Name plate (see chapter 2.1.2 - "Name plate")
	Arrow indicating the direction of rotation		CE mark in compliance with the directive 2006/42/EC
	California Proposition 65 mark (only for USA)		Do not dispose as part of domestic waste
	Adhesive label concerning the circuit breaker		RCM mark (only for Australia)
	Medical product in accordance with the IVD directive 98/79/EC (In-vitro diagnostica)		China RoHS 2 mark (only for China)

i
NOTE

Safety indications on the centrifuge must be kept readable at all times. If necessary, they must be replaced.

3 Safety

3.2 Explanation of the symbols and notes

In this operating manual, the following names and symbols to indicate hazards are used:



DANGER

This symbol stands for a **direct** hazard to the life and health of persons.

Non-observance of these symbols **causes** serious health problems up to life-endangering injuries.



DANGER

This symbol stands for a **direct** hazard to the life and health of persons due to electrical voltage.

Non-observance of these symbols **causes** serious health problems up to life-endangering injuries.



WARNING

This symbol stands for a **potential** hazard to the life and health of persons.

Non-observance of these symbols **can** cause serious health problems up to life-endangering injuries.



CAUTION

This symbol indicates a potentially hazardous situation

Non-observance of these notes can cause minor injuries or damage to property.



NOTE

This symbol indicates important information.

3.3 Responsibility of the operator

The operator undertakes to authorise only trained, specialised personnel to work on the centrifuge (see chapter 3.4 - "Operating personnel").

The areas of responsibility of the personnel concerning the operation, maintenance, and care of the unit must be clearly defined.

The safety-conscious work of the personnel in compliance with the operating manual and the relevant EC health and safety directives, and the national laws concerning health and safety and the prevention of accidents must be checked at regular intervals (e.g. every month).

Under the international rules for health and safety at work, the operator is obliged to:

- take measures in order to prevent danger to life or health during work.
- ensure that the centrifuges are used properly and entirely as intended (see chapter 1.2 - "Intended use").
- take protective measures against fire and explosion when working with hazardous substances.
- take measures for the safe opening of the centrifuges.

The operator must perform a risk assessment concerning potential accidents in connection with the centrifuge and take design-related countermeasures, if necessary.

The centrifuge has to be maintained regularly (see chapter 8 - "Maintenance and service").

Components that are not in a perfect state must be replaced immediately.

3.4 Operating personnel

Only trained, specialised personnel are authorised to operate the unit. The persons operating the unit must

- be familiar with the fundamental health, safety, and accident prevention regulations.
- have read and understood this operating manual, in particular the safety sections and warning notes, and confirmed this with their signature.

3.5 Informal safety instructions

- This operating manual is a part of the product.
- The operating manual must be kept at the location of use of the centrifuge. Ensure that it is accessible at all times.
- The operating manual must be handed over to any subsequent owner or operator of the centrifuge.
- Any changes, additions or updates received must be added to the operating manual.
- In addition to the operating manual, the general and local rules and regulations concerning the prevention of accidents and the protection of the environment must also be supplied.
- Safety and danger indications on the centrifuge must be kept readable at all times. If necessary, they must be replaced.

3 Safety

3.6 Safety instructions

3.6.1 Electrical safety

To reduce the risk of electrical shock, the centrifuge uses a three-wire electrical cord and plug to connect the equipment to earth-ground. To preserve this safety feature:



DANGER

- Ensure that the wall socket is properly wired and grounded.
- Check that the mains voltage agrees with the nominal voltage listed on the name plate.
- Do not place vessels containing liquid on the centrifuge lid or within the safety distance of 30 cm around the centrifuge. Spilled liquids may get into the centrifuge and damage electrical or mechanical components.
- Only qualified and specialised personnel are authorised to perform service tasks or repairs of the electrical system for which the housing needs to be removed.
- Inspect the electrical equipment of the unit regularly. Defects such as loose or burnt cables must be eliminated immediately.
- Following the completion of any type of repair or service, the qualified and specialised personnel must perform final inspection and testing in compliance with the relevant standards.

3.6.2 Mechanical safety

In order to ensure the safe operation of the centrifuge, observe the following:



WARNING

- Do not open the lid when the rotor is in motion!
- Do not reach into the rotor chamber when the rotor is in motion!
- Do not use the centrifuge if it was installed incorrectly.
- Do not use the centrifuge without panels.
- Do not use the centrifuge if the rotors and inserts show signs of corrosion or other defects.
- Only use the centrifuge with rotors and accessories that have been approved by the manufacturer. In case of doubt, contact the manufacturer (see chapter 7.3 - "Service contact").
- Do not hold your fingers between the lid and the housing when closing the lid. Risk of crushing!
- Defective lid relieving devices could cause the centrifuge lid to fall (contact the service department, if necessary). Risk of crushing!
- Do not hit or move the centrifuge during its operation.
- Do not lean against or rest on the centrifuge during its operation.
- Do not spin any substances that could damage the material of the rotors and buckets of the centrifuge in any way. Highly corrosive substances, for example, damage the material and affect the mechanical strength of the rotors and buckets.
- Stop the centrifuge immediately in the event of a malfunction. Eliminate the malfunction (see chapter 7 - "Malfunctions and error correction") or inform the service department of the manufacturer (see chapter 7.3 - "Service contact").

WARNING

- Ensure that all repairs are performed only by authorised and specialised personnel.
- Prior to any start-up, check the centrifuge, rotor, and accessories for signs of damage that can be discerned from the outside. Special attention must be paid to all of the rubber parts (e.g. motor cover, lid seal, and adapters) in terms of visible structural changes. Defective parts must be replaced immediately.
- Open the centrifuge when it is not in use so that moisture can evaporate.

3.6.3 Safety Instructions for robot-controlled centrifuges

This centrifuge is designed to be loaded by a robot system and is usually remote-controlled via PC. For safe handling of the centrifuge, the following safety instructions must be observed:

DANGER

- The centrifuge must be equipped with light barriers or secured doors to prevent unauthorized access during centrifugation.
- Do not reach into the rotor chamber through the open slid cover when the centrifuge is connected to the mains power. This can lead to considerable physical damages!

3.6.4 Fire prevention

DANGER

- Do not spin explosive or inflammable substances.
- Do not use the centrifuge within hazardous locations.

3.6.5 Chemical and biological safety

If pathogenic, toxic, or radioactive samples are intended to be used in the centrifuge, it is in the responsibility of the user to ensure that all necessary safety regulations, guidelines, precautions, and practices are adhered to accordingly.

DANGER

- Infectious, toxic, pathogenic, and radioactive substances may only be used in special, certified containment systems with a bio-seal in order to prevent the material from being released.
- Take suitable precautions for your own safety if there is a risk of toxic, radioactive, or pathogenic contamination
- Materials that chemically react with each other with a high level of energy are prohibited.

WARNING

- Keep informed about local measures to avoid harmful emissions (depending on the substances to be centrifuged).
- Protective clothing is not required for the operation of the centrifuge. The materials to be centrifuged may, however, require special safety measures (e.g. centrifugation of infectious, toxic, radioactive, or pathogenic substances).

3 Safety

3.6.6 Safety instructions for centrifugation

For safe operation, observe the following before starting the centrifuge:



WARNING

- Ensure that the centrifuge was set up properly (see chapter 5 - "Set-up and connection").
- Maintain a safety distance of at least 30 cm (12 inches) around the centrifuge.
- Do not store any dangerous goods in the centrifuge area.
- Do not stay in the safety area longer than what is absolutely necessary for the operation of the centrifuge.
- Only use the centrifuge with rotors and accessories that have been approved by the manufacturer. We explicitly warn against the use of equipment of poor quality. Breaking glass or bursting vessels can cause dangerous imbalances at high speeds
- Ensure that rotor and buckets are correctly fitted (see chapter 6.2.2.1 - "Installation of the rotor").
- Observe the instructions on the installation of accessories (see chapter 6.2.2.2 - "Installation of accessories").
- The rotor must be loaded in a rotationally symmetrical manner at equal weights.
- If liquids with a density $> 1.2 \text{ g/cm}^3$ are used, reduce the speed (see chapter 2.2.2.2 - "Density").
- Do not use the centrifuge if the rotor is loaded asymmetrically.
- Do not use the centrifuge with tubes that are excessively long.



WARNING

3.6.7 Resistance of plastics

Chemical influences have a strong effect on the polymeric chains of plastics, and, therefore, on their physical properties. Plastic parts can be damaged if solvents, acids, or alkaline solutions are used.



NOTE

- Refer to the resistance data (see chapter 11.5 - "Resistance data")!

3.6.8 Safety of rotors and accessories

3.6.8.1 Service life

The rotors and accessories have a limited service life.



WARNING

- Perform regular checks (at least once per month) for safety reasons!
- Pay special attention to changes, such as corrosion, cracks, material abrasion, etc.
- After 10 years, they must be inspected by the manufacturer.
- After 50,000 cycles, the rotor must be scrapped for reasons of safety.
- If other data concerning the service life are engraved on the rotor or bucket, these data shall apply accordingly. For example, a bucket with the engraving "max. cycles = 10,000" has a service life of 10,000 cycles, and a rotor with the engraving "Exp. date 01/27" must be scrapped in January 2027 at the latest (see figure).
- If a specification concerning the maximum number of cycles **and** a specification concerning the service life (i.e. a date) are provided, the specification that occurs first shall apply.

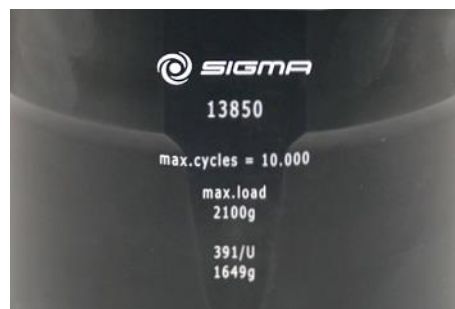

Fig. 6: Different service life – engraving on the bucket/rotor



- Refer to the table of rotors and accessories with a different service life (see chapter 11.4 - " Table of the service life of rotors and accessories ")!

3 Safety

3.7 Safety devices

3.7.1 Lid lock device

The centrifuge can only be started when the lid is properly closed. The electrical lock must be locked. The lid can only be opened when the rotor has stopped. If the lid is opened by way of the emergency release system during operation, the centrifuge will immediately switch off and decelerate brakeless. If the lid is open, the drive is completely separated from the mains power supply, i.e. the centrifuge cannot be started (see chapter 7.1.1 - "Emergency lid release").

3.7.2 Standstill monitoring system

Opening of the centrifuge lid is only possible if the rotor is at a standstill. This standstill is checked by the microprocessor.

3.7.3 System check

An internal system check monitors the data transfer and sensor signals with regard to plausibility. The system continuously performs a self-check and identifies malfunctions. Error messages are displayed as "Error" followed by a code number (see chapter 7.2 - "Table of error codes").

3.7.4 Earth conductor check

For the earth conductor check, there is an equipotential bonding screw on the rear panel of the centrifuge (see chapter 2.1.1 - "Functional and operating elements"). An earth conductor check can be carried out by authorized and specialized personnel using a suitable measuring instrument. Please contact the service department (see chapter 7.3 - "Service contact").

3.7.5 Imbalance monitoring system

The indication "Imbalance" in the rotor field and, in some cases, also a sound signal indicate that the centrifuge is in the impermissible imbalance range. The drive will be switched off in the acceleration phase or during the run.

3.7.6 Temperature monitoring system

If the temperature inside the rotor chamber rises above 50°C, the drive system will be switched off automatically. The centrifuge cannot be restarted until it has cooled.

3.7.7 Rotor monitoring system

When a rotor number and, if applicable, a bucket number are selected, the computer will automatically check whether the entered speed or the entered gravitational field are permissible for the selected rotor.

3.8 Measures in the event of hazards and accidents



DANGER

- If an emergency arises, switch off the centrifuge immediately!
- If in doubt, call the emergency doctor!

3.9 Remaining hazards

The centrifuge was built in accordance with the state of the art and in compliance with the generally recognized safety rules. However, danger to life and limb of the operator, or of third parties, or impairments of the unit or other material assets cannot be completely excluded when the unit is being used.

- Use the unit only for the purpose that it was originally intended for (see chapter 1.2 - "Intended use").
- Use the unit only if it is in a perfect running state.
- Immediately eliminate any problems that can affect safety.

4 Storage and transport

4 Storage and transport

4.1 Dimensions and weight

	Sigma 4-5KRL, Sigma 4-5KRL IVD
Height:	406 mm
Height with open lid:	890 mm
Width:	677 mm
Depth:	680 mm
Weight:	135 kg

4.2 Storage conditions

The centrifuge can be stored in its original packaging for up to a year.

- Store the centrifuge only in dry rooms.
- The permissible storage temperature is between -20°C and +60°C.
- If you would like to store it for more than one year, or if you intend to ship it overseas, please contact the manufacturer.

4.3 Notes on transport

- Install the transport safety device (see chapter 4.5 - "Transport safety device")
- Always lift the centrifuge with a lifting device.
- When lifting the centrifuge, always reach under the centrifuge from the side.



CAUTION

The centrifuge weighs approx. 135 kg!

- For transport, use suitable packaging and, if at all possible, the original packaging (see chapter 4.4 - "Packaging").

4.4 Packaging

The centrifuge is packaged in a wooden crate.

- After taking off the lid, remove the side panels.
- Remove the packaging material.
- Lift the centrifuge upwards with a lifting device to lift it safely. When lifting the centrifuge, always reach under the centrifuge from the side.



VORSICHT

The centrifuge weighs approx. 135 kg!

- Retain the packaging for any possible future transport of the centrifuge.

4.5 Transport safety device

The transport safety device consists of two hexagon socket screws which are located at the bottom panel.



CAUTION

The transport safety device must be removed prior to start-up because the screws lock the motor bearings!

Removal

- Lift the centrifuge upwards at the front side. Always reach under from the side.
- Put a suitable object, e.g. a wooden block, between the table and centrifuge. The two screws can now be seen at the bottom panel.

1 Locking screws

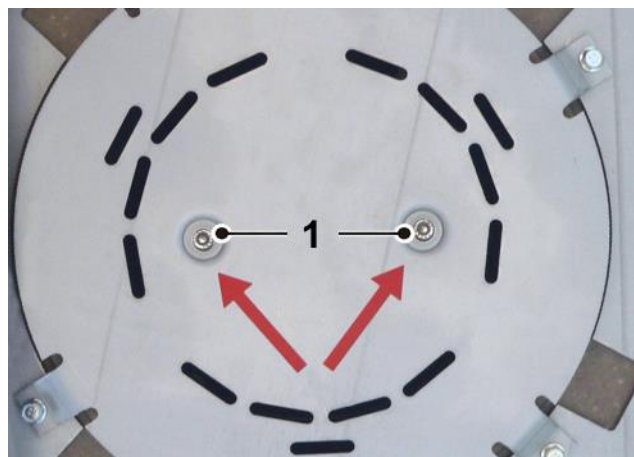

Fig. 7: Locking screws (transport safety device)

- Unscrew the hexagon socket screws with a hexagon socket wrench (size 4, included in the scope of supply) anti-clockwise.
- Retain the transport safety device for the possibility of the return of the centrifuge.

5 Set-up and connection

5 Set-up and connection

5.1 Installation site

Operate the centrifuge only in closed and dry rooms.

All the energy supplied to the centrifuge is converted into heat and emitted to the ambient air.

- Ensure sufficient ventilation.
- Keep a safety distance of at least 30 cm around the centrifuge so that the vents in the centrifuge remain fully effective.
- Do not subject the centrifuge to thermal stress, e.g. by positioning it near heat generators.
- Avoid direct sunlight (UV radiation).
- The table must be stable and have a solid, even surface.
- Attention: During transport from cold to warmer places, condensational water will collect inside the centrifuge. It is important to allow sufficient time for drying (min. 24 h) before the centrifuge can be used again.

5.2 Power supply

5.2.1 Type of connection



DANGER

The operating voltage on the name plate must correspond to the local supply voltage!



CAUTION

The mains power plug is an isolating device which is why it must be accessible at all times.

Sigma centrifuges are units of protection class I. The centrifuges of this model series have a three-wire power cord with an IEC C13 connector.



NOTE

The removable power cord must not be longer than 3 m!
The power cord must not be replaced with a power cord of inadequate rating!

The centrifuges are equipped with a mains power switch with an integrated thermal circuit breaker.

- Switch the unit off by actuating the mains power switch.
- If it has tripped, let the circuit breaker cool for approximately 2 minutes.
- Switch the unit on.

The centrifuge is now ready for operation.

5.2.2 Customer-provided fuses

Typically, the centrifuge must be protected with 16 Amp L or B fuses that are to be provided by the customer.



To ensure safe disconnection in the event of a fault, an AC/DC-sensitive RCD (residual current device) must be integrated in the wiring system of the building.

6 Using the centrifuge

6 Using the centrifuge

6.1 Initial start-up



DANGER

- Before the initial start-up, please ensure that your centrifuge is properly set up and installed (see chapter 5 - "Set-up and connection").

6.2 Switching the centrifuge on

- Press the mains power switch.
The display then illuminates. The centrifuge is ready for operation.



NOTE

The start key remains inactive and can only be activated via the connected PC or by entering a code.

Entering the code

- Press and hold the stop key while entering the code.
- Turn the function knob 1 notch to the left and then 3 notches to the right.
- Release the stop key.

The start key will be illuminated, the centrifuge is ready for operation.

6.2.1 Opening and closing the lid

The lid can be opened if the centrifuge is at a standstill and if the lid key is illuminated.

- Press the lid key in order to open the lid.

The centrifuge cannot be started if the lid is opened.

- To close, press with both hands slightly on the lid until the lock is audibly locked.



WARNING

Do not place your fingers between the lid and the housing when closing the lid. Risk of crushing!

6.2.2 Installation of rotors and accessories

6.2.2.1 Installation of the rotor

- Open the centrifuge lid by pressing the lid key.
- Unscrew the rotor tie-down screw from the motor shaft (counter-clockwise).
- Lower the rotor with its central bore straight down onto the motor shaft.
- Tighten the rotor tie-down screw clockwise with the supplied rotor wrench with 10 Nm (option: torque spanner 10 Nm, part no. 17060). In doing so, hold the rotor at its outer rim.
- Follow the safety instructions and hazard warnings (see chapter 3 - "Safety")!

**CAUTION**

When using rotors for microtiter plate formats:

Ensure that the plate holders are inserted together with the plates into the buckets.

**NOTE**

The lid screw serves for the fastening of the lid onto the rotor only, not for the fastening of the rotor onto the motor shaft.

Removal of a rotor

- Loosen the rotor tie-down screw by turning it anti-clockwise and remove the rotor.

6.2.2.2 Installation of accessories

- Only use vessels that are suitable for the rotor (see chapter 11.1 - "Suitable accessories").
- In the case of swing-out rotors, all of the compartments must be equipped with buckets.
- Always load rotationally symmetrical compartments of the rotors with the same accessories and fill to avoid imbalance.

6 Using the centrifuge

Centrifugation with vessels of various sizes

Working with vessel of various sizes is possible. In this case, however, it is very important that the rotationally symmetrical inserts are identical (see figure).

correct

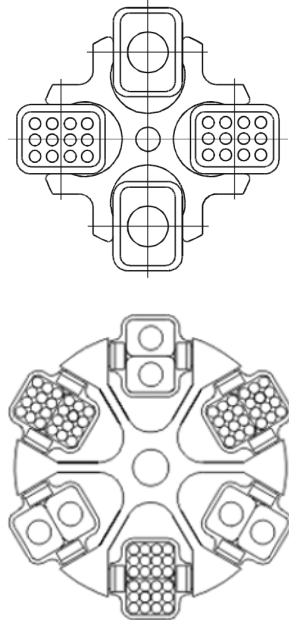

incorrect

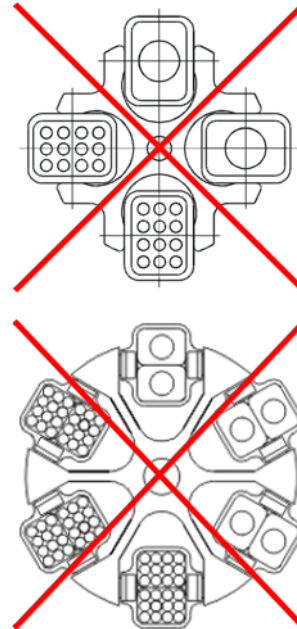
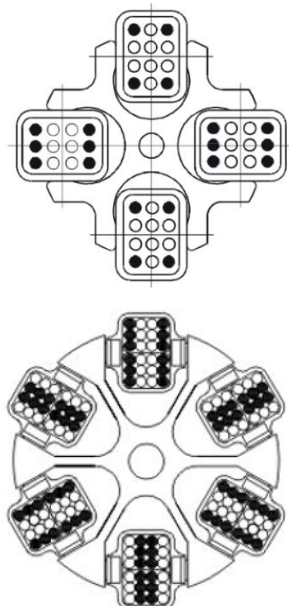

Fig. 8: Permissible and impermissible loading of a swing-out rotor with vessels of various sizes (example illustration)

Centrifugation with low capacity

- Install the sample vessels in a rotationally symmetrical manner so that the buckets and their suspensions are loaded evenly.

correct



incorrect

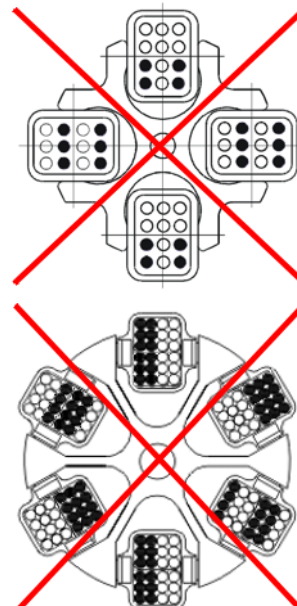

Fig. 9: Permissible and impermissible loading of a swing-out rotor (example illustrations)

6.2.2.3 Adapters

In order to ensure easy handling, even if vessels of various sizes are used, carrier systems were developed.

- Load the opposite adapters with the same number of vessels and with the same weights in order to avoid imbalance.
- If all of the compartments of a carrier are not used, the buckets must be loaded evenly. Loading the edges of a bucket only is not permissible.

6.2.2.4 Vessels

- Load the vessels outside of the centrifuge. Liquids in the buckets or multiple carriers cause corrosion.
- Fill the vessels carefully and arrange them according to their weight. Imbalances result in the excessive wear of the bearings.
- Always fill the tubes up to their useful volume (= the volume that is stated for the tube).
- When using glass vessels, the maximum value of 4,000 x g must not be exceeded (except special high-strength glass vessels; please refer to the information provided by the manufacturer).
- Follow the safety instructions and hazard warnings (see chapter 3 - "Safety")!

6 Using the centrifuge

6.3 Control system "Spincontrol L"

6.3.1 User interface

The centrifuge is operated via three buttons with integrated light-emitting diodes and one function knob. The display is divided into several different fields. The various functions of the system can be called up by pressing and turning the function knob.

- 1 Start key
- 2 Function knob
- 3 Display
- 4 Stop key
- 5 Lid key

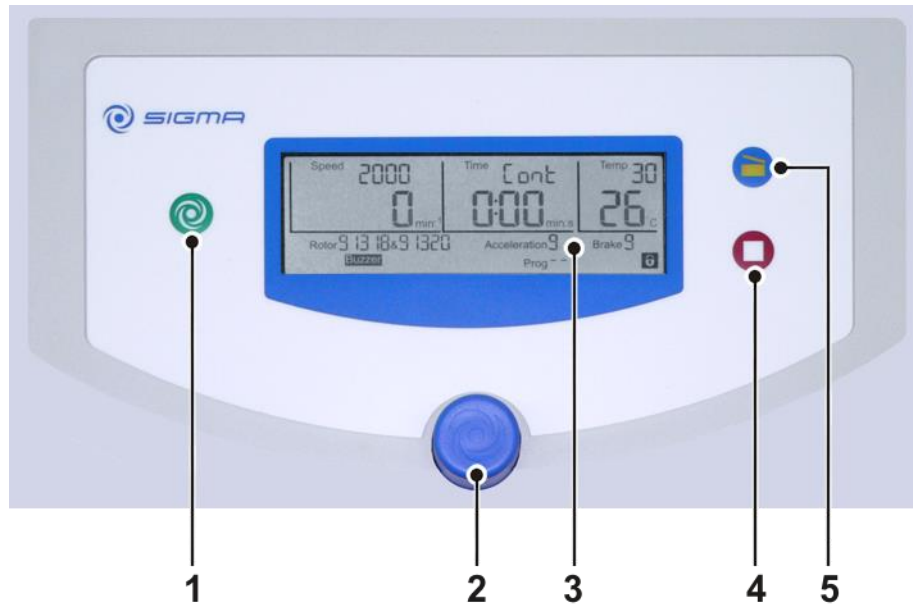

Fig. 10: User interface of the Spincontrol L control system

Display

The centrifuge display has the following display fields:

- 1 Speed/RCF field
- 2 Several display fields (e.g. for rotor, deceleration curve or program selection)
- 3 Time field
- 4 Temperature field

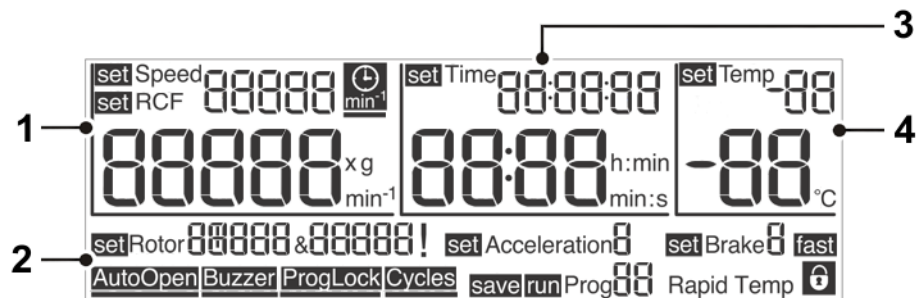

Fig. 11: Display of the Spincontrol L control system

6.3.2 Manual mode

6.3.2.1 Starting a centrifugation run

The centrifuge is ready for operation when the start key is illuminated.

- Press the start key in order to start a centrifugation run.

6.3.2.2 Interrupting a centrifugation run

- Press the stop key in order to interrupt a centrifugation run. The centrifugation run will be terminated prematurely.

Quick stop

- Press the stop key for more than two seconds.

The centrifuge decelerates with the maximum deceleration curve.

After a quick stop, the centrifuge lid must be opened before a new centrifugation run can be started.

A quick stop can also be triggered during a normal deceleration, e.g. in order to speed up the deceleration.

When a quick stop is triggered, "fast" will be displayed in the lower right-hand corner of the display.

6.3.2.3 Interrupting a deceleration process

- Press the start key during a deceleration process in order to interrupt it and to restart the centrifuge.

6.3.2.4 Selection, display, and modification of data

- Turn the function knob in order to select a field. The selected field will be preceded by the indication "set", "run", or "save".
- Press the function knob. The indication ("set", "run", or "save") flashes and the modification mode is active.
- Turn the function knob in order to modify the set value of the selected field.
- Press the function knob again to confirm the input and to quit the modification mode
- The process will be interrupted if the stop key is pressed or after 60 seconds without any further input.

6 Using the centrifuge

6.3.2.1 Speed / relative centrifugal force (RCF)

The set speed of the centrifuge is displayed in the upper area of the Speed/RCF field. The actual value is displayed right below. The speed is stated as the number of revolutions per minute ($\text{min}^{-1} = \text{rpm}$) and the RCF values as a multiple of the gravitational acceleration ($\times g$). The values are interdependent (see chapter 2.2.2.1 - "Speed, radius, and relative centrifugal force"). The maximum speed/RCF values depend on the rotor that is used.

The parameters speed and RCF can be changed during the centrifugation.



Fig. 12: Setting the speed value or the RCF value

6.3.2.2 Runtime

The set runtime is displayed in the upper section of this field, with the remaining runtime shown below. The runtime is counted down from the set value, starting with the start of the centrifuge and ending with the start of the deceleration phase. The maximum runtime is 99 h:59 min:59 sec. As of 59 min:59 sec, the unit switches from "h:min" to "min:s".

The parameter runtime can be changed during the centrifugation.



If the runtime is changed during an active centrifugation run, the time that has already elapsed will not be taken into consideration. The centrifuge will perform a complete run with the new runtime.



Fig. 13: Setting the runtime, here in the time unit "min:s"

6 Using the centrifuge

Runtime as of the set speed

If the runtime is to be counted as of the moment when the set speed is reached, the symbol (see the illustration) behind the set speed value must be activated:

- Select the clock symbol with the cursor and confirm the selection. The symbol and the bar under the symbol start to flash.
- Activate the function by turning the function knob. The symbol remains displayed in a permanent manner and the bar continues to flash.
- Further turning of the function knob will deactivate the function. In this case, the symbol disappears but the bar continues to flash.
- Press the function knob in order to activate the desired setting. The bar remains visible as long as the cursor is placed on the symbol.



Fig. 14: The function "Runtime as of the set speed" is activated

Continuous run

During the continuous run, the runtime of the centrifuge is unlimited and must be stopped manually. The centrifuge accelerates during the continuous run until the set speed is reached.

- Select the "Time" field and press the function knob. The indication "set" flashes in the activated status.
- Turn the function knob from the time 0:00:10 anti-clockwise or from the time 99:59:59 clockwise. The indication "Cont" will be displayed in the "Time" field. During the centrifugation run, the elapsed time will be displayed.
- Deactivate the continuous run by pressing the stop key or by entering a specific runtime.

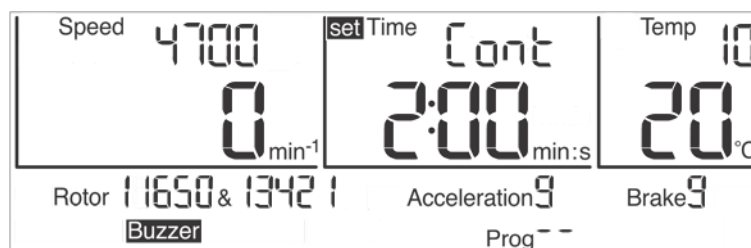

Fig. 15: Indication "Cont" during a continuous run

6 Using the centrifuge

Short run

A short run can be started if no run is active.

- Keep the start key pressed during the short run.

During the short run, the centrifuge accelerates with the acceleration curve 9 (maximum) until the maximum permissible speed of the rotor is reached. The runtime is counted and in the "Time" field the indication "Short" is displayed.

When the start key is released, the centrifuge decelerates to a standstill based on the maximum deceleration curve.

When the short run is completed, the original parameters (curves, runtime, and final speed) are restored and displayed.



Fig. 16: Indication "Short" during a short run

6.3.2.3 Temperature

The set value is displayed in the upper area of the field and the actual sample temperature is displayed in the lower area. Temperatures between -10 °C and +40 °C can be preselected.



The centrifuge is not equipped with an active heater. This is why temperatures above room temperature depend on the air friction of the turning rotor.



fig. 17: Setting the temperature

Precooling

Depending on the substances to be centrifuged, it may make sense to precool the centrifuge. The precooling prevents the cooled samples in the uncooled centrifuge from heating up to an inadmissible temperature.



Unmoved air in the rotor chamber distorts the measuring and control behavior and causes the compressor to freeze over. At temperatures below 0 °C, aqueous liquids will freeze, making sedimentation impossible.

- Ensure that the rotor temperature will not fall below 0 °C when the rotor is at a standstill!

6 Using the centrifuge

Program "Rapid Temp"

The centrifuge has a special "Rapid Temp" program that precools the centrifuge rapidly under defined conditions.

- Select the program with the aid of the menu item "run Prog" (see chapter 6.3.3.2 - "Loading a program"). The speed display shows $\frac{1}{3}$ of the maximum rotor speed, the deceleration (brake) and acceleration curves correspond to curve 9 and the runtime field indicates "Cont" (continuous run). "Rapid Temp" will flash next to the "run" display.



Fig. 18: "Rapid Temp" program



The program will only be loaded if the actual temperature is above the set temperature.

- Press the start button in order to start the rapid cooling process.
- During the rapid cooling process, the set temperature can be modified within the range below the actual temperature.

The "Rapid Temp" program will be stopped under the following conditions:

- The set value is reached. The program will stop with a sound signal if this function is activated.
- The stop button is pressed. The program will be stopped prematurely.
- A parameter is changed (except for the temperature and rotors/buckets). In this case, the program will be aborted.

After the stop, the previous program will be reloaded or the changed parameters will be adopted as the new settings.



The automatic lid opening function ("AutoOpen") is suppressed after a rapid cooling phase in order to prevent the system from reheating.



If the "Rapid Temp" program is used, the temperature of the unloaded aluminium bucket will be displayed. If samples, which have not been precooled, are placed into the buckets after a "Rapid Temp" run, the displayed temperature will deviate from the actual sample temperature.

6 Using the centrifuge

6.3.2.4 Rotor selection

This field shows the rotor that is currently being used.



The rotor selection can only be changed when the centrifuge is at a standstill.

- Select the "Rotor" field and confirm the selection. The indication "set" flashes in the activated status.
- Select the desired rotor. If there are rotors with several different types of possible buckets, the various combinations will be displayed one after the other.
- Confirm the input. The selected rotor or rotor/bucket combination will be adopted.



Fig. 19: Preselection of a rotor or a rotor/bucket combination

Automatic rotor identification system

If the centrifuge is equipped with an automatic rotor identification system, the input mode will be activated automatically if the system detects a different rotor with several different types of possible buckets than the rotor that is set. The bucket that is displayed is the bucket with the lowest maximum speed. You can only select different types of buckets for the identified rotor. If the input mode is aborted, this bucket will be stored nonetheless.

This prevents the maximum permissible speed from being exceeded.

6.3.2.5 Acceleration and deceleration curves
Acceleration

This function is used to select an acceleration curve. The system offers 10 fixed, programmed acceleration curves (curves 0-9).

Brake

This function is used in order to select a curve that decelerates the centrifuge to a standstill. Deceleration curves are inverted images of the acceleration curves and are labelled with identical numbers. Deceleration curve no. 0 represents a brakeless deceleration.



Fig. 20: Preselection of a curve; here: preselection of an acceleration curve

6.3.2.6 Program lock ("ProgLock")

When the program lock is active, it is impossible to save any new programs. In this case, the function "save program" is disabled.

In order to activate the program lock:

- Select the "ProgLock" symbol with the cursor and confirm the selection. The symbol and the bar under the symbol start to flash.
- Activate the function by turning the function knob. The symbol remains displayed in a permanent manner and the bar continues to flash.
- Turning the function knob further will deactivate the function. In this case, the symbol disappears but the bar continues to flash.
- Press the function knob in order to activate the desired setting. The bar remains visible as long as the cursor is placed over the symbol.



Fig. 21: The program lock "ProgLock" is activated

6 Using the centrifuge

6.3.2.7 Cycle display ("Cycles")

In order to activate the cycle display:

- Select the "Cycles" symbol with the cursor and confirm the selection. The symbol is displayed and "set" flashes in front of the rotor display.
- All of the rotors and buckets can be selected by turning the function knob. The cycles of the selected rotor and, if applicable, also of the selected bucket are displayed.
- Press the function knob in order to quit the cycle display.



Fig. 22: Cycle display for rotor 11650 and bucket 13421

Reaching the maximum number of cycles

When the maximum number of cycles is reached for a rotor or bucket, a corresponding warning signal will be displayed every time that the centrifuge is started: the start key, lid key, and entire display will flash.

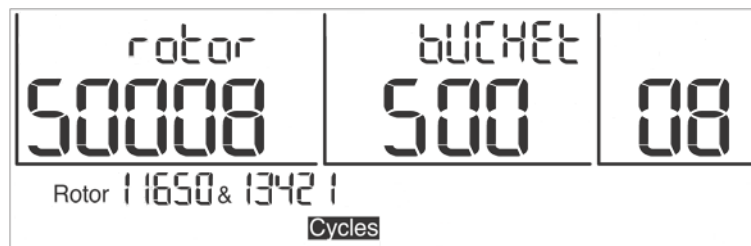

Fig. 23: Display when the maximum number of cycles is reached (flashing)

When the start key is pressed, "CYCLES" will be displayed. The centrifuge will not be started and the display will not return to its normal state until the start key is pressed again.



WARNING

When the maximum number of cycles of the rotor or bucket is reached, the parts must be replaced immediately for safety reasons (see chapter 3.6.8.1 - "Service life").

The cycle display will be reset after the rotor and buckets have been replaced by the service department of Sigma Laborzentrifugen GmbH (see chapter 7.3 - "Service contact").

6 Using the centrifuge

6.3.2.8 Input lock

In order to prevent the centrifuge from being manipulated by unauthorised persons, inputs can be disabled via the menu. Inputs via the keypad, i.e. for starting or stopping a centrifugation run or for opening the lid, are enabled.

Activating a simple input lock:

- Position the cursor over the symbol "🔒" in the lower right-hand corner of the display.

As long as the symbol is displayed, the parameters of the centrifuge cannot be changed.

Activating a permanent input lock:

- Press the start key three times and hold for approximately 2 seconds when pressing it for the third time.

After the activation of this function, the padlock symbol flashes. The input lock is activated.

- Proceed in the same manner in order to deactivate the permanent input lock.



Fig. 24: "Padlock" symbol indicating an activated input lock



If the centrifuge is robot-controlled via the computer, the display can only be used for display purposes. Only the stop key is active at all times and can be used to switch the centrifuge off in an emergency situation.

6.3.3 Program mode

A program contains all the data that are required for a centrifuge run. Certain sedimentation results can be repeated under identical conditions. Programs can be saved, loaded, executed, and edited when the centrifuge is at a standstill.

A maximum of 50 programs can be stored under the numbers 1 - 50. The rapid cooling program "Rapid Temp" does not occupy any storage location and cannot be deleted. It is used to cool the centrifuge without any vessels. "--" means that the values that are currently set are not a stored program.

The programs can be protected against unauthorised use, modification, or deletion with the aid of an input lock (see chapter 6.3.2.8 - "Input lock").

6 Using the centrifuge

6.3.3.1 Saving a program



This function is only available if the centrifuge is at a standstill.

- Enter the parameters that are to be included in the program.
- Select the menu item "save Prog" and confirm the selection. The indication "save" flashes in the activated status.
- Select a random storage location from the program selection list. Free storage locations are indicated by a flashing display. Any storage locations that are already occupied will be overwritten during the saving process.
- Save the program in the desired location.

The program is now saved.



The functions "Auto Open", "Buzzer", "ProgLock", and "Cycles" cannot be entered as part of a program.



Fig. 25: Saving a program

6.3.3.2 Loading a program

- Select the menu item "run Prog" and confirm the selection. The indication "run" flashes in the activated status.
- Select the desired program and confirm the selection by pressing the function knob.

The program is now loaded.



Fig. 26: Loading a program

6.4 Use as a robot-controlled centrifuge

In addition to manual operation, the centrifuge is also suitable for being loaded by a robot. A separate computer is used for the control.

6.4.1 Connection

The back of the centrifuge is equipped with a serial interface (see chapter 2.1.1 - "Functional and operating elements") for connecting a computer.

- Plug the connecting cable (included in the scope of supply) into the intended port on the back of the centrifuge.

The centrifuge can now be controlled via the computer.



If the centrifuge is controlled via the computer, the display can only be used for display purposes. Only the stop key is active at all times and can be used to switch the centrifuge off in an emergency situation.

6.4.2 Rotors

Robot-controlled centrifuges require special rotors that are equipped with magnets on the bottom surface (see fig.). They are necessary in order to ensure the correct position of the rotor. When the desired position is reached, the rotor is locked mechanically. The slide cover in the lid opens during the locking of the rotor either automatically depending on the input command or separately following another command.



During loading or unloading, the slide cover can stay open when the rotor turns to the next position. This accelerates the process.

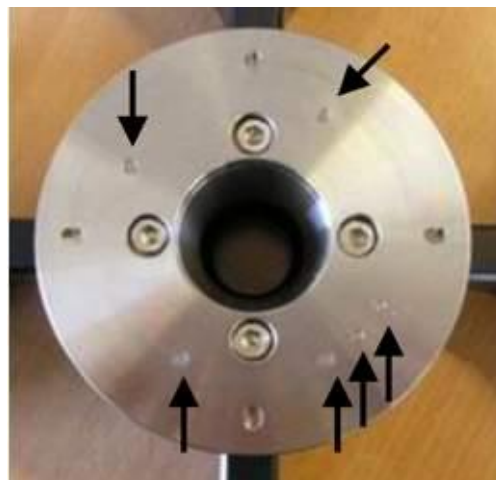

Fig. 27: Magnets on the bottom surface of the rotor

6 Using the centrifuge

6.4.3 Input

The centrifuge can be controlled with several input commands. The input commands are divided into several categories:

- Check commands, these commands trigger an immediate action
- Change of input values
- Display of current process values
- Display of current input values
- Indication of the centrifuge status
- Display of parameters



A complete list of these commands and several examples can be found in chapter 11.6 - "Serial Control Interface Specification"

6.4.3.1 Positioning of the rotor

If the centrifuge is loaded and unloaded by way of a robot, special rotors are used (see chapter 6.4.2 - "Rotors"). These rotors are positioned via an input command.

The command "setpos n" moves the rotor automatically to the desired position where it is then locked. During the positioning process, the message "Posi" will be displayed in the upper area of the speed/RCF field while a dynamic progress bar below this area indicates the progress or duration of the process. The command that is to be executed will be displayed in the upper area of the time and temperature field while the lower area shows the selected rotor position.

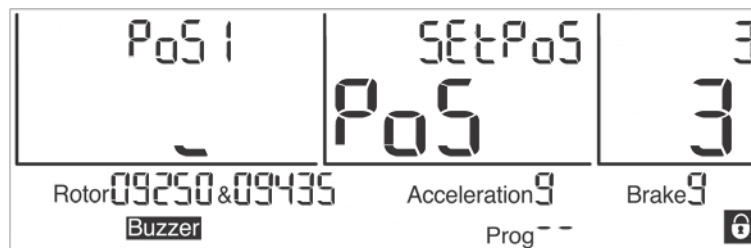

Fig. 28: Indication during the positioning process

When the positioning process has been completed and the rotor has been locked in the selected position, the message "Lock" will be displayed in the speed/RCF field. The rotor is now in the correct position.



Fig. 29: Indication after the completion of the positioning process

6.5 Switching the centrifuge off

- Open the centrifuge when it is not in use so moisture can evaporate.
- Switch the centrifuge off by pressing the mains power switch.

7 Malfunctions and error correction

7 Malfunctions and error correction

7.1 General malfunctions

Error messages are displayed as "Error" followed by a code number. If the acoustic signal is activated, it sounds when the error message is displayed.

- Eliminate the source of the problem (see table below).
- Acknowledge the error messages by pressing the lid key.



Error messages can be eliminated by pressing the lid key. The error itself will not be eliminated, but the centrifuge can be operated again.

Type of error	Possible reason	Correction
No indication on the display	No power in the mains supply	Check fuse in the mains supply
	Power cord is not plugged in	Plug in power cord correctly
	Fuses have tripped	Reactivate temperature fuse (see chapter 5.2.1 - "Type of connection")
	Mains power switch off	Switch mains power switch on
Centrifuge cannot be started: start key LED is not illuminated	The start key is inactive	Activate the start key (see chapter 6.2 - "Switching the centrifuge on"). If the error occurs again, contact service
Centrifuge cannot be started: lid key LED flashes	The lid lock is not closed correctly	Open and close the lid. If the error occurs again, contact service
Centrifuge decelerates during operation	Brief mains power failure	Press start key in order to restart the centrifuge
	System error	Power off/on. If the error occurs again, contact service
Centrifuge decelerates during operation, imbalance message is displayed	<ul style="list-style-type: none"> – Improper loading – Centrifuge is inclined – Drive problem – Centrifuge was moved during run 	Balance load and restart the centrifuge. If the error occurs again, contact service
	– Ungreased load-bearing bolts	Clean and grease load-bearing bolts
Lid cannot be opened	Lid lock has not released	Unlock the lid manually (see chapter 7.1.1 - "Emergency lid release") and contact service
	Lid seal sticks	Clean the lid seal and apply talcum powder
Temperature value cannot be reached (only for refrigerated centrifuges)	Condenser dirty (only air-cooled units)	Clean the condenser. If the error occurs again, contact service
Hard running noise during the centrifugation	Screws of the transport safety device are not removed	Remove screws of the transport safety device (see chapter 4.5 - "Transport safety device")

7 Malfunctions and error correction

7.1.1 Emergency lid release

In the event of a power failure, it is possible to manually open the centrifuge lid.

- Switch off the mains power switch and disconnect the power cord from the socket.
- Remove the stopper (see figure, item 1) from the opening on the right side panel, e.g. with a screwdriver.



Fig. 30: Position of the opening for the emergency lid release

- The stopper is connected with a string. Pull the string in order to release the lid.
- Then, reinsert the stopper into the opening.



WARNING

Do not unlock or open the lid unless the rotor is at a standstill.

If the lid is opened via the emergency lid release system during a centrifuge run, the centrifuge will be switched off immediately and decelerate in an unbraked manner.

7 Malfunctions and error correction

7.2 Table of error codes

Error no.	Kind of error	Measures	Note
1-9	System error	<ul style="list-style-type: none"> Allow to slow down Power off/on 	All these errors stop the centrifuge or cause it to decelerate brakeless
10-19	Speedometer error	<ul style="list-style-type: none"> Allow to slow down Power off/on 	
20-29	Motor error	<ul style="list-style-type: none"> Power off Ensure ventilation 	
30-39	EEPROM error	<ul style="list-style-type: none"> Allow to slow down Power off/on 	With error 34, 35, and 36, the centrifuge will stop; with error 37 and 38 only an error message will be given
40-45	Temperature error (only for refrigerated centrifuges)	<ul style="list-style-type: none"> Allow to slow down Power off Allow to cool down Provide better ventilation (only air cooled centrifuges) Provide sufficient water throughput (only water cooled centrifuges) 	
46-49	Imbalance error (only for centrifuges with imbalance monitoring system)	<ul style="list-style-type: none"> Allow to slow down Power off Eliminate the imbalance 	
50-59	Lid error	<ul style="list-style-type: none"> Press lid key Close lid Remove foreign matter from the opening of the lid lock device 	With error 50 and 51, the centrifuge will stop
60-69	Process error	<ul style="list-style-type: none"> Allow to slow down Power off/on 	With error 60, the message "power failure during run" will be displayed, with error 61, the message "stop after power on" will be displayed
70-79	Communication error	<ul style="list-style-type: none"> Allow to slow down Power off/on 	
80-89	Parameter error	<ul style="list-style-type: none"> Power off Allow to cool down Provide for better ventilation 	With error 83, error message only
90-99	Other errors	<ul style="list-style-type: none"> Check connections Provide sufficient water throughput (only water cooled centrifuges) 	



If it is impossible to eliminate the errors, contact the service!

7.3 Service contact

In the event of queries, malfunctions, or spare part enquiries:

From Germany:

Contact

Sigma Laborzentrifugen GmbH
An der Unteren Söse 50
37520 Osterode (Germany)
Tel. +49 (0) 55 22 / 50 07-44 44
E-mail: support.lab@sigma-zentrifugen.de

Outside Germany:

Contact our agency in your country. All agencies are listed at
www.sigma-zentrifugen.de → [Sales Partners]



NOTE

- If you would like to utilise our service, please state the type of your centrifuge and its serial number.

8 Maintenance and service

8 Maintenance and service

The centrifuge, rotor, and accessories are subject to high mechanical stress. Thorough maintenance performed by the user extends the service life and prevents premature failure.



CAUTION

If corrosion or other damage occurs due to improper care, the manufacturer cannot be held liable or subject to any warranty claims.

- Use soap water or other water-soluble, mild cleaning agents with a pH value between 6 and 8 for cleaning the centrifuge and accessories (see also chapter 8.2 - "Sterilisation and disinfection of the rotor chamber and accessories").
- Avoid corrosive and aggressive substances.
- Do not use solvents.
- Do not use agents with abrasive particles.
- Do not expose the centrifuge and rotors to intensive UV radiation or thermal stress (e.g. by heat generators).

8.1 Maintenance

8.1.1 Centrifuge

- Unplug the mains power plug before cleaning.
- Carefully remove all liquids, including water and particularly all the solvents, acids, and alkaline solutions from the rotor chamber using a cloth in order to avoid damage to the motor bearings.
- If the centrifuge has been contaminated with toxic, radioactive, or pathogenic substances, clean the rotor chamber immediately with a suitable decontamination agent (depending on the type of contamination).



WARNING

Take suitable precautions for your own safety if there is a risk of toxic, radioactive, or pathogenic contamination.

- After every cleaning process, grease the motor shaft slightly with a small amount of heavy-duty grease for load-bearing bolts (part no. 71401) and distribute the grease with a cloth so that it forms a thin layer.

8.1.1.1 Condenser (only refrigerated centrifuges with an air-cooled refrigeration system)

In order to cool the refrigerant that is compressed by the refrigeration unit, centrifuges with an air-cooled refrigeration system use a lamellar condenser. It is cooled by air.

Dust and dirt obstruct the cooling flow of air. The dust on condenser pipes and lamellas reduces the heat exchange and thus the performance of the refrigeration unit.

This is why the installation site should be as clean as possible.

- Check the condenser at least once a month for dirt and clean it if necessary.
- If you have any queries, please contact service (see chapter 7.3 - "Service contact").

8.1.2 Accessories**CAUTION**

For the care of the accessories, special safety measures must be considered as these are measures that will ensure operational safety at the same time!

- Immediately rinse off the rotor, buckets, or accessories under running water if they have come into contact with any liquids that may cause corrosion. Use a brush for test tubes in order to clean the bores of angle rotors. Turn the rotor upside down and allow it to dry completely.
- Clean the accessories outside the centrifuge once a week or preferably after each use. Adapters should be removed, cleaned and dried.

**CAUTION****Do not clean the accessories in a dishwasher!**

Cleaning in a dishwasher removes the anodised coating; the result is cracking in areas that are subject to stress.

- If the rotors or accessories have been contaminated with toxic, radioactive, or pathogenic substances, clean them immediately with a suitable decontamination agent (depending on the type of contamination). Take suitable precautions for your own safety if there is a risk of toxic, radioactive, or pathogenic contamination.
- Dry the accessories with a soft cloth or in a drying chamber at approx. 50°C.

8 Maintenance and service

8.1.2.1 Plastic accessories

The chemical resistance of plastic decreases with rising temperatures (see chapter 11.5 - "Resistance data").

- If solvents, acids, or alkaline solutions have been used, clean the plastic accessories thoroughly.



WARNING

Plastic accessories must not be greased!

8.1.3 Rotors, buckets and carriers

Rotors, buckets and carriers are produced with the highest precision, in order to withstand the permanent high stress from high gravitational fields.

Chemical reactions as well as stress-corrosion (combination of oscillating pressure and chemical reaction) can affect or destroy the metals. Barely detectable cracks on the surface can expand and weaken the material without any visible signs.

- Check the material regularly (at least once a month) for
 - cracks
 - visible damage of the surface
 - pressure marks
 - signs of corrosion
 - other changes.
- Check the bores of the rotors and multiple carriers.
- Replace any damaged components immediately for your own safety.
- After every cleaning process, grease the rotor tie-down screw slightly with a small amount of heavy-duty grease for load-bearing bolts (part no. 71401) and distribute the grease with a cloth so that it forms a thin layer.

8.1.4 Load bearing bolts

Only greased load-bearing bolts ensure a uniform swing-out of the buckets and, therefore, the smooth operation of the centrifuge. Load-bearing bolts that are insufficiently greased may cause the centrifuge to stop due to an imbalance.

- Clean the load-bearing bolts and bucket groove in order to remove the old grease.
- Apply a small amount of heavy-duty grease for load-bearing bolts (ref. no. 71401, see the following picture) to both load-bearing bolts of a bucket.



Fig. 31: Sufficient quantity of grease for one bolt

- Install the bucket and swing it manually back and forth once in order to distribute the grease.
- Repeat this process with all the other buckets.

8 Maintenance and service

8.1.5 Glass breakage



CAUTION

In the case of glass breakage, immediately remove all glass particles (e.g. with a vacuum cleaner). Replace the rubber cushions since even thorough cleaning will not remove all glass particles.

Glass particles will damage the surface coating (e.g. anodising) of the buckets, which will then lead to corrosion.

Glass particles in the rubber cushions of the buckets will cause glass breakage again.

Glass particles on the pivot bearing of the load-bearing bolts prevent the buckets and carriers from swinging evenly, which will cause an imbalance.

Glass particles in the rotor chamber will cause metal abrasion due to the strong air circulation. This metal dust will not only pollute the rotor chamber, rotor, and materials to be centrifuged but also damage the surfaces of the accessories, rotors, and rotor chamber.

In order to completely remove the glass particles and metal dust from the rotor chamber:

- Grease the upper third of the rotor chamber with e.g. Vaseline.
- Then, let the rotor rotate for a few minutes at a moderate speed (approx. 2000 rpm). The glass and metal particles will now collect at the greased part.
- Remove the grease with the glass and metal particles with a cloth.
- If necessary, repeat this procedure.

8.2 Sterilisation and disinfection of the rotor chamber and accessories

- Use commercially-available disinfectants such as, for example, Sagrotan®, Buraton®, or Terralin® (available at chemist's shops or drugstores).
- The centrifuge and the accessories consist of various materials. A possible incompatibility must be considered.
- Before using cleaning or decontamination agents that were not recommended by us, contact the manufacturer to ensure that such a procedure will not damage the centrifuge.
- For autoclaving, consider the continuous heat resistance of the individual materials (see chapter 8.2.1 - "Autoclaving").

Please contact us if you have any queries (see chapter 7.3 - "Service contact").



DANGER

If dangerous materials (e.g. infectious and pathogenic substances) are used, the centrifuge and accessories must be disinfected.

8.2.1 Autoclaving

The service life of the accessories essentially depends on the frequency of autoclaving and use.

- Replace the accessories immediately when the parts show changes in colour or structure or in the occurrence of leaks etc.
- During autoclaving, the caps of the tubes must not be screwed on in order to avoid the deformation of the tubes.



NOTE

It cannot be excluded that plastic parts, e.g. lids or carriers, may deform during autoclaving.

Accessories	Max. temp. (°C)	Min. time (min)	Max. time (min)	Max. cycles
Aluminium buckets	134-138	3	5	-
Aluminium rotors	134-138	3	5	-
Glass tubes	134-138	3	40	-
Polyallomer / polycarbonate rectangular carriers	115-118	30	40	-
Polyallomer / polycarbonate round carriers	115-118	30	40	-
Polyamide buckets	115-118	30	40	10
Polycarbonate / polyallomer lids for angle rotors	115-118	30	40	20
Polycarbonate tubes	115-118	30	40	20
Polyphenylsulfone (PPSU) caps for buckets	134-138	3	5	100
Polypropylene balance adapter for blood-bag systems	115-118	30	40	n.s.
Polypropylene copolymer tubes	115-121	30	40	20
Polypropylene rectangular carriers	115-118	30	40	-
Polypropylene rotors	115-118	30	40	20
Polypropylene round carriers	115-118	30	40	-
Polysulfone caps for buckets	134-138	3	5	100
Polysulfone lids for angle rotors	134-138	3	5	100
Rubber adapters	115-118	30	40	-
Stainless-steel balance weight for blood-bag systems	121	30	30	n.s.
Teflon tubes	134-138	3	5	100

8 Maintenance and service

8.3 Service



DANGER

In the event of service work that requires the removal of the panels, there is a risk of electric shock or mechanical injury.

- Only qualified specialist personnel is authorised to perform this service work.
- Following the completion of any type of service, the qualified and specialised personnel must perform final inspection and testing in compliance with the relevant standards.

The centrifuge is subject to high mechanical stress. In order to be able to withstand this high level of stress, high-quality components were used during the production of the centrifuge. Nevertheless, wear cannot be excluded and it may not be visible from the outside. Especially the rubber parts that are – among other things – part of the motor suspension, are subject to ageing.

This is why we recommend having the centrifuge checked by the manufacturer during an inspection once per year in the operating state and once every three years in the dismantled state. Rubber parts should be replaced after three years.

Information and appointments:

In Germany:

Contact
Sigma Laborzentrifugen GmbH
An der Unteren Söse 50
37520 Osterode (Germany)
Tel. +49 (0) 55 22 / 50 07-44 44
E-mail: support.lab@sigma-zentrifugen.de

Outside Germany:

Contact our agency in your country. All agencies are listed at www.sigma-zentrifugen.de → [Sales Partners]



NOTE

- If you would like to utilise our service, please state the type of your centrifuge and its serial number.

8.4 Return of defective centrifuges or parts

Although we exercise great care during the production of our products, it may be necessary to return a unit or accessory to the manufacturer.

In order to ensure the quick and economical processing of returns of centrifuges, spare parts, or accessories, we require complete and extensive information concerning the process. Please fill in the following forms completely, sign them, enclose them with the return package, and send them together with the product to:

Sigma Laborzentrifugen GmbH
An der Unteren Söse 50
37520 Osterode (Germany)

1. Declaration of decontamination

As a certified company and due to the legal regulations for the protection of our employees and of the environment, we are obliged to certify the harmlessness of all incoming goods. For this purpose, we require a declaration of decontamination.

- The form must be filled in completely and signed by authorised and specialised personnel only.
- Affix the original form in a clearly visible manner to the outside of the packaging.



We will return the part/unit if no declaration of decontamination is provided!

2. Form for the return of defective parts

This form is for the product-related data. They facilitate the assignment, and they enable the quick processing of the return. If several parts are returned together in one packaging, please enclose a separate problem description for every defective part.

- A detailed problem description is necessary in order to perform the repair quickly and economically.



If the form does not include a description of the malfunction, neither a refund nor a credit note can be issued. In this case, we reserve the right to return the part/unit to you at your expense.

- Upon request, we will prepare and submit to you a cost estimate prior to performing the repair. Please confirm such cost estimate within 14 days. If the cost estimate has still not been confirmed after 4 weeks, we will return the defective part/unit. Please note that you must bear the incurred costs.

8 Maintenance and service



The defective part/unit must be packaged in a transport-safe manner. Please use the original packaging for the unit, if at all possible. If the product is dispatched to us in unsuitable packaging, you will be charged the cost for returning it to you in new packaging.

The forms can be downloaded online from
www.sigma-zentrifugen.de → [Service] → [Overhaul and repair].

9 Disposal

9.1 Disposal of the centrifuge



In accordance with the directive 2012/19/EU, SIGMA centrifuges are marked with the symbol shown to the left. This symbol means that it is not permissible to dispose of the unit among household waste.

- You can return these centrifuges free of cost to Sigma Laborzentrifugen GmbH.
- Ensure that the unit is decontaminated. Fill in a declaration of decontamination (see chapter 8.4 - "Return of defective centrifuges or parts").
- Comply with any other applicable local rules and regulations.

9.2 Disposal of the packaging

- Use the packaging to return the centrifuge for disposal or
- dispose of the packaging, after having separated the individual materials.
- Comply with all local rules and regulations.

10 Technical data

10 Technical data

Manufacturer	Sigma Laborzentrifugen GmbH An der Unteren Söse 50 37520 Osterode (Germany)	
Type:	4-5KRL	4-5KRL IVD
Part no.:	91309, 91564	100008, 100009
<u>Connection requirements</u>		
Electrical connection:	see name plate	
Protection class:	I	
IP code:	20	
Power consumption (kW):	1.5	
Input fuse (AT):	12.0 (temperature fuse)	
Series fuse at the transformer (AT):	16.0 (temperature fuse, 1-phase)	
<u>Performance data</u>		
Max. speed (rpm):	4,700	
Max. capacity (ml):	840	
Max. gravitational field (x g):	4,470	
Max. kinetic energy (Nm):	20,078	
<u>Other parameters</u>		
Time range:	10 sec – 99 h 59 min 59 sec, short run, continuous run	
Temperature range:	-10°C to +40°C	
Storage locations:	50	
<u>Physical data</u>		
Height (mm):	406	
Height with open lid (mm):	890	
Width (mm):	677	
Depth (mm):	680	
Weight (kg):	135	
Noise level (dB(A)):	< 59 (at maximum speed)	
<u>Refrigerant data</u>		
Refrigerant:	R134a	
Filling quantity (kg):	0.500	
Max. permissible pressure (bar):	23	
CO ₂ equivalent (t):	0.650	

10.1 Ambient conditions

- The figures are valid for an ambient temperature of +23°C and a nominal voltage $\pm 10\%$. The minimum temperature is $\leq +4^\circ\text{C}$ and depends on the rotor type, speed, and ambient temperature.



At a nominal voltage of 100V or 200V, a tolerance of +10% / -5% applies.

- For indoor use only.
- Allowable ambient temperature +5°C to +35°C.
- Max. allowable relative humidity of air 80% from 5°C up to 31°C with a linear decrease to 67% relative humidity of air at 35°C.
- Maximum altitude 2,000 m above sea level.

10.2 Technical documentation

For environmental reasons, the comprehensive technical documentation of the centrifuge (e.g. circuit diagrams) and the safety data sheets of the manufacturers of refrigerants and lubricants are not attached to this documentation.

You can order these documents from our service department.

11 Appendix

11 Appendix

11.1 Suitable accessories

For use in a robot-controlled centrifuge, special equipment is required.
Please contact our sales department:

SIGMA Laborzentrifugen GmbH
An der Unteren Söse 50
37520 Osterode (Germany)
Tel. +49 (0) 55 22 / 50 07-82 13
Fax +49 (0) 55 22 / 50 07 92 13
E-mail: info@sigma-zentrifugen.de



DANGER

Rotors and accessories of the standard-centrifuge 4-5L must not be used in a robot-controlled centrifuge **without consultation with the manufacturer!**

11.1.1 Rotor radii

The information in the accessories table concerning the radius refers to the values of the respective rotor as shown below. The radius calculation is described in chapter 2.2.2.1 - "Speed, radius, and relative centrifugal force".

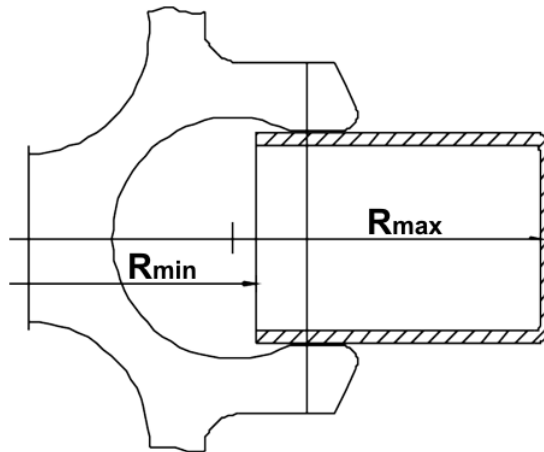

Fig. 32: Minimum and maximum radius of a swing-out rotor

11.2 Speed-gravitational-field-diagram

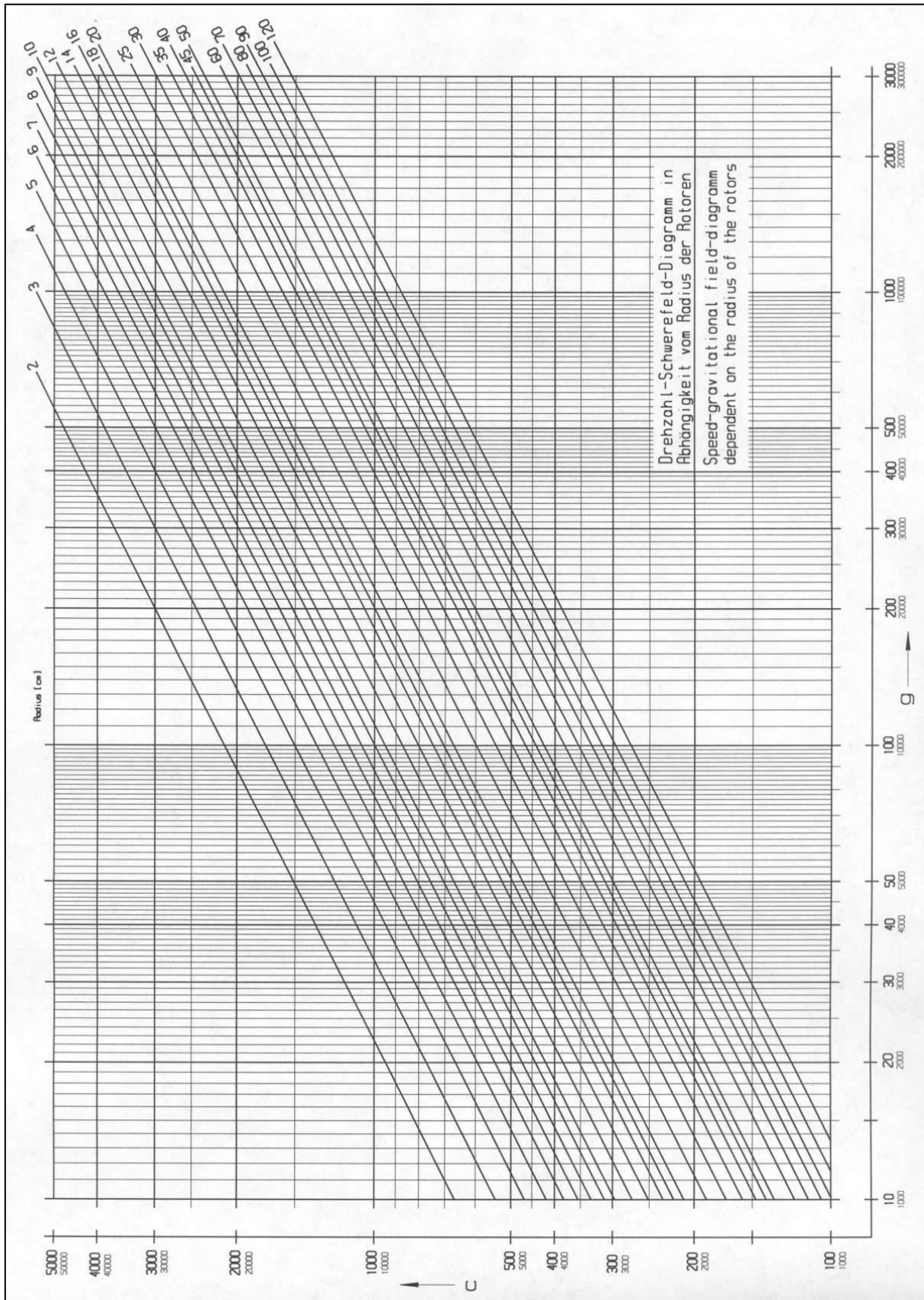

Fig. 33: Speed-gravitational-field-diagram

11 Appendix

11.3 Acceleration and deceleration curves

Linear curves are numbered in the direction of increasing acceleration (from right to left).

The deceleration curves are inverted images of the acceleration curves and are assigned the same numbers. An exception is curve 0. It decelerates brakeless (spin-out).

In general, the runtime, until the set speed is reached, depends on the moment of inertia of the rotor.

Linear curves

The slope of the fixed acceleration curves defines the time that is required to accelerate the rotor by 1,000 rpm.

Curve 9 is a special case compared to the other curves. The centrifuge accelerates with maximum power. The runtime, until the set speed is reached, depends solely on the moment of inertia of the rotor.

Linear curve no.	Slope
0	4 [rpm/sec]
1	6 [rpm/sec]
2	8 [rpm/sec]
3	17 [rpm/sec]
4	25 [rpm/sec]
5	33 [rpm/sec]
6	50 [rpm/sec]
7	100 [rpm/sec]
8	200 [rpm/sec]
9	1.000 [rpm/sec]

Fig. 34: Slope of linear curves

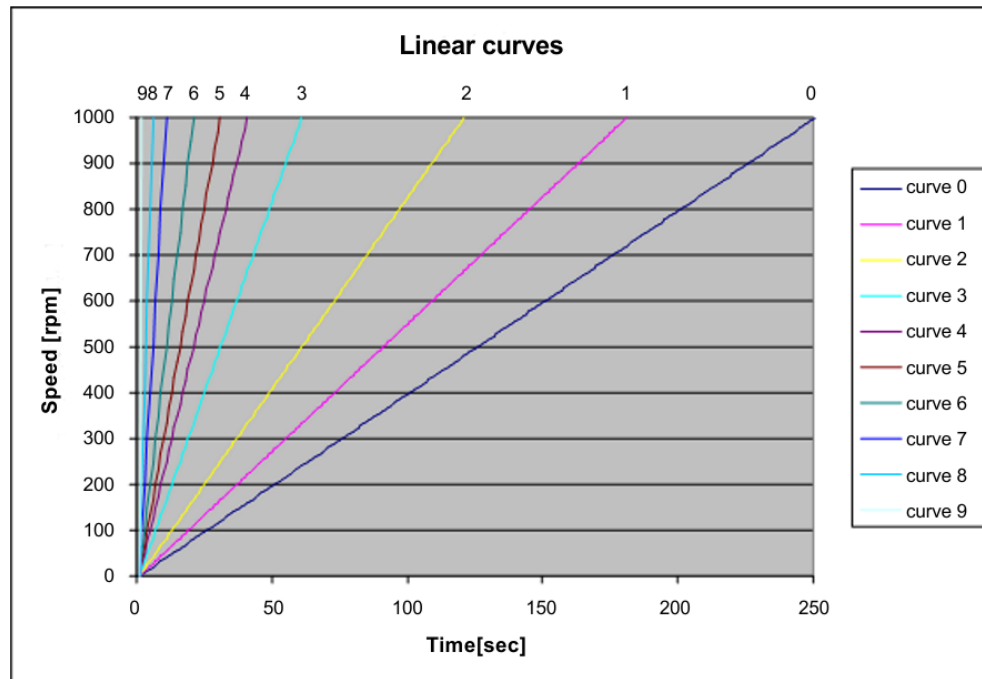

Fig. 35: Diagram of linear curves

11.4 Table of the service life of rotors and accessories

- If no other data concerning the service life are engraved on the rotor or accessory, rotors and buckets must be checked by the manufacturer after 10 years.
- If a specification concerning the maximum number of cycles **and** a specification concerning the service life (i.e. a date) are provided, the specification that occurs first shall apply.
- After 50,000 cycles, rotors must be scrapped for safety reasons.

Rotor / bucket	Cycles	Service life ("Exp.Date")	Autoclaving	Suitable for centrifuge	Remarks
9100	15,000			4-15C, 4K15C, 4-16, 4-16S, 4-16K, 4-16KS, 6-15, 6K15, 6-16, 6-16K	without engraving, only "spincontrol professional" and "spincontrol S"
11026		7 years		1-14, 1-14K	
11805 / 13850	10,000	10 years		8K, 8KB, 8KS, 8KBS	
11805 / 13860	10,000	10 years		8K, 8KB, 8KS, 8KBS	
11806		10 years		8K, 8KB, 8KS, 8KBS	
12033		5 years		1-16 Edition, 1-16K Edition	
12082		7 years		1-14, 1-14K	
12083		7 years		1-14, 1-14K	
12084		7 years		1-14, 1-14K	
12085		7 years		1-14, 1-14K	
12092		5 years	20x	1-14, 1-14K	
12093		5 years	20x	1-14, 1-14K	
12094		5 years	20x	1-14, 1-14K	
12096		5 years	20x	1-14, 1-14K	
12097		5 years	20x	1-14, 1-14K	
12101		5 years	20x	1-15, 1-15K, 1-15P, 1-15PK	
12124		5 years	20x	1-15, 1-15K, 1-15P, 1-15PK	
12126		5 years	20x	1-15, 1-15K, 1-15P, 1-15PK	
12134		5 years	20x	1-16, 1-16K	
12135		5 years	20x	1-16, 1-16K	
12137		5 years	20x	1-16, 1-16K	
12500		7 years		6-15, 6K15, 6-16, 6-16K	
12600		7 years		6-16S, 6-16KS	
13218	20,000			4-16, 4-16S, 4-16K, 4-16KS, 6-16, 6-16S, 6-16K, 6-16KS	
13296	35,000	5 years	10x	2-6, 2-6E, 2-7, 2-16P, 2-16KL, 2-16KHL	
13299		5 years	10x	2-6, 2-6E, 2-7, 2-16P, 2-16KL, 2-16KHL	
13635	25,000			6-16, 6-16K, 6-16S, 6-16KS	
13650	20,000			4-5L, 4-16S, 4-16KS, 4-16KHS, 6-16S, 6-16HS, 6-16KS, 6-16KHS	
13845	20,000			8K, 8KB, 8KS, 8KBS	
13850	10,000*	10 years		8K, 8KB, 8KS, 8KBS	*in combination with rotor 11805
13860	15,000*	10 years		8K, 8KB, 8KS, 8KBS	*in combination with rotor 11805
13864	1,000			8K, 8KB, 8KS, 8KBS	without engraving
13865	1,000			8K, 8KB, 8KS, 8KBS	without engraving
13866	1,000			8K, 8KB, 8KS, 8KBS	without engraving
13867	2,500			8K, 8KB, 8KS, 8KBS	without engraving
13868	5,000			8K, 8KB, 8KS, 8KBS	without engraving
13869	5,000			8K, 8KB, 8KS, 8KBS	without engraving
13870	5,000			8K, 8KB, 8KS, 8KBS	without engraving

11 Appendix

11.5 Resistance data



The data refer to resistance at 20°C.

- no data 1 resistant 2 practically resistant 3 partially resistant 4 not resistant	Concentration	High Density Polyethylene	Polyamide	Polycarbonate	Polyoxymethylene	Polypropylene	Polysulfone	Polyvinyl chloride, hard	Polyvinyl chloride, soft	Polytetrafluorethylene	Acrylonitrile-butadiene-caoutchouc	Aluminium	
													Medium
Acetaldehyde	C ₂ H ₄ O	40	3	2	4	2	3	4	4	-	1	4	1
Acetamide	C ₂ H ₅ NO	saturated	1	1	4	1	1	4	4	-	1	-	1
Acetone	C ₃ H ₆ O	100	1	1	4	1	1	4	4	-	1	4	1
Acrylonitrile	C ₃ H ₃ N	100	1	1	4	3	3	4	4	4	1	4	1
Allyl alcohol	C ₃ H ₆ O	96	1	3	3	2	2	2	2	4	1	1	1
Aluminium chloride	AlCl ₃	saturated	1	3	2	4	1	-	1	-	1	1	4
Aluminium sulfate	Al ₂ (SO ₄) ₃	10	1	1	1	3	1	1	1	1	1	1	1
Ammonium chloride	(NH ₄)Cl	aqueous	1	1	1	2	1	1	1	1	1	1	3
Ammonium hydroxide	NH ₃ + H ₂ O	30	1	3	4	1	1	2	1	-	1	-	1
Aniline	C ₆ H ₇ N	100	1	3	4	1	2	4	4	4	1	4	1
Anisole	C ₇ H ₈ O	100	3	4	4	1	4	4	2	-	1	4	1
Antimony trichloride	SbCl ₃	90	1	4	1	4	1	-	1	-	1	-	4
Benzaldehyde	C ₇ H ₆ O	100	1	3	4	1	1	3	4	4	1	4	1
Benzene	C ₆ H ₆	100	3	2	4	1	3	4	4	-	1	4	1
Boric acid	H ₃ BO ₃	aqueous	1	3	1	2	1	-	-	-	1	1	1
Butyl acrylate	C ₇ H ₁₂ O ₂	100	1	2	4	2	3	4	4	4	1	-	1
Butyl alcohol, normal	C ₄ H ₁₀ O	100	1	1	2	1	1	2	2	4	1	1	1
Calcium chloride	CaCl ₂	alcoholic	1	4	2	3	1	-	-	4	1	1	3
Carbon disulfide	CS ₂	100	4	3	4	2	4	4	4	4	1	3	1
Carbon tetrachloride (TETRA)	CCl ₄	100	4	4	4	2	4	4	4	4	1	3	1
Chlorine	Cl ₂	100	4	4	4	4	4	4	4	4	1	-	3
Chlorine water	Cl ₂ x H ₂ O		3	4	4	4	3	-	3	3	1	-	4
Chlorobenzene	C ₆ H ₅ Cl	100	3	4	4	1	3	4	4	4	1	4	1
Chloroform	CHCl ₃	100	3	3	4	4	3	4	4	4	1	4	3

11 Appendix

- no data 1 resistant 2 practically resistant 3 partially resistant 4 not resistant	Medium	Formula	Concentration [%]	High Density Polyethylene	Polyamide	Polycarbonate	Polyoxymethylene	Polypropylene	Polysulfone	Polyvinyl chloride, hard	Polyvinyl chloride, soft	Polytetrafluorethylene	Acrylonitrile-butadiene- caoutchouc	Aluminium
				HDPE	PA	PC	POM	PP	PSU	PVC	PVC	PTFE	NBR	AL
	Chromic acid	CrO ₃	10	1	4	2	4	1	4	1	-	1	4	1
	Chromic potassium sulphate	KCr(SO ₄) ₂ x 12H ₂ O	saturated	1	2	1	3	1	-	1	-	1	-	3
	Citric acid	C ₆ H ₈ O ₇	10	1	1	1	2	1	1	1	1	1	1	1
	Citric acid	C ₆ H ₈ O ₇	50	1	3	1	2	1	-	-	-	1	1	1
	Copper sulphate	CuSO ₄ x 5H ₂ O	10	1	1	1	1	1	1	1	1	1	1	4
	Cyclohexanol	C ₆ H ₁₂ O	100	1	1	3	1	1	1	1	4	1	2	1
	Decane	C ₁₀ H ₂₂	100	-	1	2	1	3	-	-	-	1	2	1
	Diaminoethane	C ₂ H ₈ N ₂	100	1	1	3	1	1	-	3	4	1	1	1
	Diesel fuel	—	100	1	1	3	1	1	-	1	3	1	1	1
	Dimethyl formamide (DMF)	C ₃ D ₇ NO	100	1	1	4	1	1	4	3	-	1	3	1
	Dimethyl sulfoxide (DMSO)	C ₂ H ₆ SO	100	1	2	4	1	1	4	4	-	1	-	1
	Dimethylaniline	C ₈ H ₁₁ N	100	-	3	4	2	4	-	-	-	1	-	1
	Dioxane	C ₄ H ₈ O ₂	100	2	1	4	1	3	2	3	4	1	3	1
	Dipropylene glycol (mono)methyl ether	C ₄ H ₁₀ O	100	3	1	4	1	4	4	4	4	1	-	1
	Ethyl acetate	C ₄ H ₈ O ₂	100	1	1	4	1	1	4	4	4	1	4	1
	Ethylene chloride	C ₂ H ₄ Cl ₂	100	3	3	4	1	3	4	4	4	1	-	1
	Ferrous chloride	FeCl ₂	saturated	1	3	1	3	1	1	1	1	1	-	4
	Formaldehyde solution	CH ₂ O	30	1	3	1	1	1	-	-	-	1	2	1
	Formic acid	CH ₂ O ₂	100	1	4	3	4	1	3	3	1	1	2	1
	Furfural	C ₅ H ₄ O ₂	100	1	3	3	2	4	-	-	-	1	4	1
	Gasoline	C ₅ H ₁₂ - C ₁₂ H ₂₆	100	2	1	3	1	3	3	2	-	1	1	1
	Glycerol	C ₃ H ₈ O ₃	100	1	1	3	1	1	1	1	2	1	1	1
	Heptane, normal	C ₇ H ₁₆	100	2	1	1	1	2	1	2	4	1	1	1
	Hexane, n-	C ₆ H ₁₄	100	2	1	2	1	2	1	2	4	1	1	1
	Hydrogen chloride	HCl	5	1	4	1	4	1	1	1	-	1	2	4
	Hydrogen chloride	HCl	concentrated	1	4	4	4	1	1	2	3	1	4	4
	Hydrogen peroxide	H ₂ O ₂	3	1	3	1	1	1	1	1	-	1	3	3
	Hydrogen peroxide	H ₂ O ₂	30	1	4	1	4	1	1	1	-	1	3	3
	Hydrogen sulphide	H ₂ S	10	1	1	1	1	1	1	1	3	1	3	1
	Iodine, tincture of	I ₂		1	4	3	1	1	-	4	4	1	1	1

11 Appendix

- no data 1 resistant 2 practically resistant 3 partially resistant 4 not resistant		Concentration	High Density Polyethylene	Polyamide	Polycarbonate	Polyoxymethylene	Polypropylene	Polysulfone	Polyvinyl chloride, hard	Polyvinyl chloride, soft	Polytetrafluorethylene	Acrylonitrile-butadiene- caoutchouc	Aluminium	
			Medium	Formula	[%]	HDPE	PA	PC	POM	PP	PSU	PVC	PVC	PTFE
	Isopropyl alcohol	C ₃ H ₈ O	100	1	1	1	1	1	1	1	4	1	-	2
	Lactic acid	C ₃ H ₆ O ₃	3	1	3	1	2	1	1	2	-	1	1	1
	Magnesium chloride	MgCl ₂	10	1	1	1	1	1	1	1	1	1	1	1
	Mercuric chloride	HgCl ₂	10	1	4	1	3	1	1	1	1	1	1	4
	Mercury	Hg	100	1	1	1	1	1	1	1	3	1	1	3
	Methyl acetate	C ₃ H ₆ O ₂	100	1	1	4	2	1	-	4	4	1	-	1
	Methyl alcohol	CH ₄ O	100	1	2	4	1	1	3	1	3	1	2	1
	Methyl benzene	C ₇ H ₈	100	3	1	4	1	3	4	4	4	1	4	1
	Methyl ethyl ketone (MEK)	C ₄ H ₈ O	100	1	1	4	1	1	4	4	4	1	4	1
	Methylene chloride	CH ₂ Cl ₂	100	4	3	4	3	3	4	4	4	1	-	1
	Mineral oil	—	100	1	1	1	1	1	1	1	-	1	1	1
	Nitric acid	HNO ₃	10	1	4	1	4	1	1	1	-	1	4	3
	Nitric acid	HNO ₃	100	4	4	4	4	4	-	4	-	1	4	1
	Nitrobenzene	C ₆ H ₅ NO ₂	100	3	4	4	3	2	4	4	4	1	4	1
	Oleic acid	C ₁₈ H ₃₄ O ₂	100	1	1	1	2	1	-	1	-	1	3	1
	Oxalic acid	C ₂ H ₂ O ₄ x 2H ₂ O	100	1	3	1	4	1	1	1	1	1	2	1
	Ozone	O ₃	100	3	4	1	4	3	1	1	-	1	4	2
	Petroleum	—	100	1	1	3	1	1	1	1	3	1	1	1
	Phenol	C ₆ H ₆ O	10	1	4	4	4	1	4	1	3	1	3	1
	Phenol	C ₆ H ₆ O	100	2	4	4	4	1	3	4	3	1	3	1
	Phosphoric acid	H ₃ PO ₄	20	1	4	2	4	1	-	-	-	1	2	4
	Phosphorus pentachloride	PCl ₅	100	-	4	4	4	1	-	4	4	1	-	1
	Potassium hydrogen carbonate	CHKO ₃	saturated	1	1	2	1	1	-	-	-	1	-	4
	Potassium hydroxide	KOH	30	1	1	4	3	1	1	1	1	1	-	4
	Potassium hydroxide	KOH	50	1	1	4	3	1	1	1	1	1	-	4
	Potassium nitrate	KNO ₃	10	1	1	1	1	1	-	-	-	1	1	1
	Potassium permanganate	KMnO ₄	100	1	4	1	1	1	-	1	-	1	3	1
	Pyridine	C ₅ H ₅ N	100	1	1	4	1	3	4	4	4	1	4	1
	Resorcinol	C ₆ H ₆ O ₂	5	1	4	2	3	1	4	2	-	1	-	2
	Silver nitrate	AgNO ₃	100	1	1	1	1	1	1	1	1	1	2	4

11 Appendix

- no data 1 resistant 2 practically resistant 3 partially resistant 4 not resistant		Concentration	High Density Polyethylene	Polyamide	Polycarbonate	Polyoxymethylene	Polypropylene	Polysulfone	Polyvinyl chloride, hard	Polyvinyl chloride, soft	Polytetrafluorethylene	Acrylonitrile-butadiene-caoutchouc	Aluminium
			Medium	Formula	[%]	HDPE	PA	PC	POM	PP	PSU	PVC	PVC
	Sodium bisulphite	NaHSO ₃	10	1	1	2	4	1	-	-	1	1	1
	Sodium carbonate	Na ₂ CO ₃	10	1	1	1	1	1	-	-	1	-	3
	Sodium chloride	NaCl	30	1	1	1	1	1	1	1	1	1	3
	Sodium hydroxide	NaOH	30	1	1	4	1	1	1	1	1	2	4
	Sodium hydroxide	NaOH	50	1	1	4	1	1	1	-	1	2	4
	Sodium sulfate	Na ₂ SO ₄	10	1	1	1	1	1	1	1	1	1	1
	Spirits	C ₂ H ₆ O	96	1	1	1	1	1	1	3	1	-	1
	Styrene	C ₈ H ₈	100	4	1	4	1	3	-	4	4	4	1
	Sulphuric acid	H ₂ SO ₄	6	1	4	1	4	1	1	1	-	1	2
	Sulphuric acid	H ₂ SO ₄	fuming	4	4	4	4	4	4	4	4	1	4
	Tallow	—	100	1	1	1	1	1	-	1	1	1	1
	Tetrahydrofuran (THF)	C ₄ H ₈ O	100	3	1	4	1	3	4	4	4	1	3
	Tetrahydronaphthalene	C ₁₀ H ₁₂	100	3	1	4	1	4	4	4	4	1	-
	Thionyl chloride	Cl ₂ SO	100	4	4	4	2	4	4	4	4	1	-
	Tin chloride	SnCl ₂	10	1	4	2	2	1	-	-	-	1	1
	Transformer oil	—	100	1	1	3	3	1	1	1	-	1	1
	Trichloroethane	C ₂ H ₃ Cl ₃	100	3	3	4	2	4	4	4	4	1	4
	Urea	CH ₄ N ₂ O	10	1	1	1	1	1	-	-	-	1	1
	Urine	—	100	1	1	1	1	1	-	1	1	1	-
	Vinegar	C ₂ H ₄ O ₂	10	1	4	1	1	1	1	1	1	1	2
	Vinegar	C ₂ H ₄ O ₂	90	1	4	4	4	1	3	1	4	1	-
	Wax	—	100	-	1	1		1	-	-	-	1	-
	Wines	—	100	1	1	1	2	1	1	1	1	1	-
	Xylene	C ₈ H ₁₀	100	3	1	4	1	4	4	4	4	1	4



11 Appendix

11.6 Serial Control Interface Specification

V2.3 SERIAL CONTROL INTERFACE SPECIFICATION 

Serial Control Interface Specification

Spincontrol

Version: V2.3
Date: 07.02.2017
File: rs232_spincontrol.doc

PAGE 1

11 Appendix

V 2. 3

SERIAL CONTROL INTERFACE SPECIFICATION



1 Contents

1 Contents	2
2 Introduction	3
3 General specifications	3
4 Communication protocol	3
4.1 Reset message	4
4.2 General user commands	4
4.2.1 Overview of commands	4
4.2.2 Control commands	4
4.2.3 Commands to change the setpoints	4
4.2.4 Commands to request process values	5
4.2.5 Commands to request setpoints	5
4.2.6 Commands to change parameters	5
4.2.7 Commands to read parameters	5
4.2.8 Commands to request the status	6
4.2.9 Other commands	6
4.3 Additional commands of Spincontrol S and Professional	9
4.3.1 Commands related to curves	9
4.3.2 Data of last run.....	10
4.3.3 Commands related to programs.....	14
4.3.4 Other commands	15
4.4 Additional commands of Spincontrol S	15
4.5 Commands of centrifuges for robot placement	16
4.5.1 Commands for control panel	17
4.5.2 Commands for motor driven lid or hatch.....	17
4.5.3 Commands for rotor positioning.....	17
4.5.4 Commands for bucket lifter unit.....	17
4.5.5 Commands for Rotor Cycle Counter	17
4.5.6 Commands for Servo Cycle Counters	18
4.6 Table of user commands	19
5 Examples	22
6 Hardware interface (optional accessory)	23
6.1 Pinning of the connector	23
6.2 Typical connection to a PC	23
7 History	24

2 Introduction

This document describes the hardware specification and software protocol to communicate with a serial RS232 connection to a sigma centrifuge with Spincontrol electronics.

The serial interface offers the possibility of firmware updates (by service technician), control and monitoring of centrifuge parameters and also the readout of service data like error list and cycles.

The communication data is ASCII coded for easy access with standard terminal software, e.g. "zoc" (<http://www.emtec.com/zoc/>) which offers an easy way to monitor and log the centrifuge process parameters.

The Spincontrol serial protocol is syntax compatible to the older Zent2 protocol used in Sigma Robot centrifuges. In contrast to the Zent2 protocol the character echo is not enabled by default. This protocol is also fully compatible to labworldsoft[®] (<http://www.labworldsoft.com/>), an innovative windows software application for laboratory automation which allows measuring, controlling and regulating of all centrifuge operations.

3 General specifications

Interface standard:	RS232
Baud rate:	9600
Parity:	No
Data bits:	8
Stopbits:	1
Data format:	ASCII

The serial communication works without hardware- or XON/XOFF software handshake.

4 Communication protocol

User commands consist of an ASCII-coded command string and - if needed - a parameter separated by a space. The command parser works non case sensitive.

The character received won't be echoed by the centrifuge processor normally, except if barcode menu is implemented in the centrifuge software. You can tell the centrifuge to echo each character by sending the "**echoon**" command. The user command and the return string of the centrifuge will always be terminated with the characters '0x0A' and '0x0D' (CR and LF).

The command "**cmderror**" can be used to ensure the correct execution of the last command.

The centrifuge outputs a prompt to indicate that it's ready to receive commands. The default prompt is "SIGMA>", but if a name is given to the centrifuge it will be expanded (to give a pc the possibility to distinguish several centrifuges) to "SIGMA xyz>" where "xyz" is the given name.

11 Appendix

V 2.3

SERIAL CONTROL INTERFACE SPECIFICATION



4.1 Reset message

Centrifuges output a message after reset. Detailed output differs by model, but all models output the reset reason first and output is done when the prompt appears. Reset reasons are:

- ~hwreset
loss of power
- ~wdreset
the watch dog timer forced a reset
- ~exreset
reset by external reset pin
- ~swreset
reset initiated by software

4.2 General user commands

The following categories of user commands are available for all models.

4.2.1 Overview of commands

An overview about available commands is output by sending "?" or "??". Both commands are equal and output of available commands depends on model.

? outputs the command list
?? outputs the command list

4.2.2 Control commands

These commands cause an immediate action.

start starts the centrifuge with the set values
stop stops the centrifuge with the pre-adjusted deceleration
fstop stops the centrifuge with the maximal deceleration
door opens the door (only possible when the rotor is stationary and centrifuge is not equipped with a motor driven hatch/lid, see chapter 4.5.2 Commands for motor driven lid or hatch)
reset resets the centrifuge. This command has the same effect as power-on
reseterr resets an error message of type "Log" and "Warning"

4.2.3 Commands to change the setpoints

Commands to change setpoints (*OUT_SP_n y*)

setspeed or **OUT_SP_1** sets the speed
settemp or **OUT_SP_2** sets the temperature (only centrifuges with cooling/heating)
settime or **OUT_SP_3** sets the runtime

4.2.4 Commands to request process values

Commands to request process values (*IN_PV_n*)

<i>speed</i>	or	<i>IN_PV_1</i>	requests the actual rotor speed
<i>temp</i>	or	<i>IN_PV_2</i>	requests the actual temperature (only centrifuges with cooling/heating)
<i>time</i>	or	<i>IN_PV_3</i>	requests the remaining time

4.2.5 Commands to request setpoints

Commands to request setpoints (*IN_SP_n*)

<i>getsetspeed</i>	or	<i>IN_SP_1</i>	requests the set rotor speed
<i>getsettemp</i>	or	<i>IN_SP_2</i>	requests the set temperature (only centrifuges with cooling/heating)
<i>getsettime</i>	or	<i>IN_SP_3</i>	requests the set time

4.2.6 Commands to change parameters

Commands to change parameters (*OUT_PAR_n y*)

<i>setaccel</i>	or	<i>OUT_PAR_1</i>	sets the acceleration
<i>setdecel</i>	or	<i>OUT_PAR_2</i>	sets the deceleration

For Spincontrol Comfort, Spincontrol Professional, Spincontrol L and Spincontrol S the parameter of these commands is the curve nr to be used for acceleration or deceleration. For Spincontrol universal, Spincontrol easy and Spincontrol basic a "0" sets the soft mode and a "1" sets the normal mode. For setdecel there is also the parameter "-1" which sets the free spinout mode.

4.2.7 Commands to read parameters

Commands to request parameters (*OUT_PAR_n*)

<i>getaccel</i>	or	<i>IN_PAR_1</i>	requests the acceleration
<i>getdecel</i>	or	<i>IN_PAR_2</i>	requests the deceleration

11 Appendix

V 2. 3

SERIAL CONTROL INTERFACE SPECIFICATION



4.2.8 Commands to request the status

status requests the status of the centrifuge. The value is displayed decimal.

Value	Normal centrifuge or with motor driven lid	Centrifuge with hatch in the lid
0	Rotor is spinning or door is opening / closing.	Rotor is spinning and the centrifuge is not in positioning mode
1	Rotor is stationary: the door can be opened	- Rotor is stationary or - during positioning (not locked) and/or hatch is not open. The hatch can be opened and the rotor is ready for positioning
2	The door is opened	The hatch is open and the rotor is locked. Ready for loading or unloading.
3	An error has occurred	An error has occurred

status1 advanced status of the centrifuge. The value is displayed hexadecimal.

Bit	Status	Normal centrifuge or with motor driven lid	Centrifuge with hatch in the lid
1..0	00	Door is opening/closing	Hatch is opening/closing or undefined or lid is open
	01	Door is open	Hatch is open
	10	Door is close	Hatch is close
	11	Not used	Not used
3..2	00	Wait	Wait
	01	Door can be opened	Hatch can be opened
	10	Door can be closed	Hatch can be closed
	11	Not used	Hatch can be opened or closed
4	0	No imbalance	No imbalance
	1	Centrifuge shut down with imbalance (only set while centrifuge breaks)	Centrifuge shut down with imbalance (only set while centrifuge breaks)
5	0	Rotor is stopped	Rotor is stopped
	1	Rotor is spinning	Rotor is spinning
6	0	No error	No error
	1	Centrifuge shut down with an error	Centrifuge shut down with an error

status2 advanced status of the centrifuge, only centrifuges for roboter placement. The value is displayed hexadecimal.

Bit	Status	Centrifuge with motor driven lid	Centrifuge with hatch in the lid
0	1	Not implemented	Lid is closed
Bit	Status	Centrifuge without bucket lifter unit	Centrifuge with bucket lifter unit
1	0	Always	Bucket is not at its lower end position
	1	Not implemented	Bucket is at its lower end position
2	0	Always	Bucket is not at its upper end position
	1	Not implemented	Bucket is at its upper end position

4.2.9 Other commands

curr Displays all current parameters tabularly: speed, temp (only centrifuges with cooling/heating), status, status1
The optional parameter "/tn" outputs the data continuously where 'n' defines the repeat rate in seconds. Entering a '.' stops monitoring. The parameter are separated by '\t'

Example with 5 seconds repeat rate:

```
curr /t5
speed temp status status1
3017 22 0 0020
3009 22 0 0020
3005 22 0 0020
3003 22 0 0020
3002 22 0 0020
.
```

V 2. 3

SERIAL CONTROL INTERFACE SPECIFICATION



cmderror Displays the error status of the last command .
The centrifuge returns '1' if no error occurred.

syserror Displays the error status (current error number) of the centrifuge
The centrifuge returns '0', if no error occurred

In case of error numbers 90, 93 and 95, additional 3 parameters are returned as decimal value with information about states of the servo units (currently only available in models with bucket lifter unit). In detail:

	Parameter 2	Parameter 3	Parameter 4
b15/14 = status of	01 = rotor lock unit	10 = slider unit	11 = bucket lifter unit
b13/12	-	-	-
b11	unknown state	unknown state	unknown state
b10	no catch	-	-
b9	time out slow	time out slow	time out slow
b8	time out fast	time out fast	time out fast
b7	switch error	switch error	switch error
b6	-	-	-
b5	-	over current while closing	-
b4	-	-	-
bit 3 (1 = S4 active)	locked switch	closed switch	up switch
bit 2 (1 = S3 active)	catched switch	nearly closed switch	nearly up switch
bit 1 (1 = S2 active)	-	nearly open switch	nearly down switch
bit 0 (1 = S1 active)	unlocked switch	open switch	down switch

geterr the same as "syserror" (for compatibility with Zent2)

geterrtimeout get the remaining safety timeout in seconds for fatal errors (centrifuges without rotor code). If '0' the centrifuge may be reset by command "reset".

11 Appendix

V 2.3

SERIAL CONTROL INTERFACE SPECIFICATION



info Displays software version and other service information like this (8K):

```

info
Centrifuge Name: 8K
Part No.: 10855, Version: 001
Device Name: Zent5 Controlboard
Part No.: 70926, Version: 001
Software Part No.: 26490 - Software Version: 009
CompilationDate: Mar 27 2007 (14:16:22)
TotalCycles: 70
TempOffset: -8
ImbalOffset: -1
SIGMA Laborzentrifugen GmbH Osterode
www.sigma-zentrifugen.de
Err      Para      Code      Timestamp
02       10       125       0
15       10       124       0
12       10       100       0
12       8        55        0
02       8        40        0
    
```

or this (2-6):

```

info
Cent:    2-6
PN:      10220
Dev:     2-6 Controlboard
PN:      70925
Ver:     001
SW PN:   26487
SW Ver:  017
comp:    Nov 7 2008 (08:58:05)
    
```

The exact output format of this command may vary between different centrifuge types.

geterrpara Because the error list with all parameters is output by "info" command on models with Spincontrol S and Spincontrol Professional only, for some other models the geterrpara command is implemented which outputs error list with all parameters (implementation depends on software version).

echoon This command activates the character echo. Every character will be echoed and the following messages are sent as acknowledge for every single command:

Return Message	Description
OK	Command successful
CNF	Command not found
NEA	Not enough arguments (e.g. set speed value missing)
ERR	Command not possible
CYCLES	"start" command received but max. cycles of rotor or bucket reached -> start command must be sent again as confirmation to ignore cycles

echooff This command de-activates the character echo.

getcurvelist Optional command. Returns curve list with Curve number, Acceleration in rpm/s, Deceleration in rpm/s, if implemented.

Output format:

```
Curve, Accel, Decel
0,100,100
1,1600,1600
```

getrotor Requests the selected rotor by rotor list index.

getrotorlist Optional command. Returns rotor list with Rotor, Bucket, minimum Radius, maximum Radius, maximum Speed and maximum Temperature, if implemented.

Output format:

```
Rotor, Bucket, Rmin, Rmax, Nmax, Tmax
11037,13035,49,133,4000,40
11171,13299,38,142,4000,40
11171,13296,65,133,4000,40
12072,0,80,139,4000,40
12073,0,58,139,4000,40
```

setrotor Selects a new rotor by rotor list index.

4.3 Additional commands of Spincontrol S and Professional

Models with Spincontrol Professional or Spincontrol S have additional commands.

4.3.1 Commands related to curves

getcurve This command returns the data of a free programmable curve. With the parameter n you can choose the curve between 20 and 29:

```
getcurve 22
CurveNr: 20
Interval 1: Time: 130 Speed: 100 LIN
Interval 2: Time: 60 Speed: 148
Interval 3: Time: 60 Speed: 194
Interval 4: Time: 60 Speed: 257
Interval 5: Time: 60 Speed: 327
Interval 6: Time: 60 Speed: 526
Interval 7: Time: 60 Speed: 800
Interval 8: Time: 30 Speed: 1000
Interval 9: Time: 600 Speed: 100
Interval 10: Time: 40 Speed: 100
TotalTime: 1160
```

11 Appendix

V 2.3

SERIAL CONTROL INTERFACE SPECIFICATION



setcurve This command sets new data for the free programmable curves. The command is followed by the parameter:

setcurve [curveNr],[Lin/Quad],[Int1Time],[Int1Speed] ,[Int2Time],[Int2Speed],etc.

Notice this command is only possible, if no free curve is running!

```
SIGMA> setcurve 22,0,130,112,60,148,60,193,60,256,60,326,60,524,60,1010
OK
SIGMA> getcurve 22
CurveNr: 22
Interval 1: Time: 130 Speed: 112 LIN
Interval 2: Time: 60 Speed: 148
Interval 3: Time: 60 Speed: 193
Interval 4: Time: 60 Speed: 256
Interval 5: Time: 60 Speed: 326
Interval 6: Time: 60 Speed: 524
Interval 7: Time: 60 Speed: 1010
Interval 8: Time: 0 Speed: 0
Interval 9: Time: 0 Speed: 0
Interval 10: Time: 0 Speed: 0
TotalTime: 490
SIGMA>
```

4.3.2 Data of last run

getlastrun This command triggers output of parameters and results of last spin in csv-Format
This command is only available for Spincontrol S.

While there was no spin since last reset, only centrifuge ID, stored barcodes and string "No data available" will be output. Else Data will be output as follows:

Item	1 st column	2 nd column	3 rd column	Condition
Centrifuge ID	Centrifuge name	not assigned yet		Always
		xy...z		No name assigned
				Name assigned
				3 rd column is empty
Barcode of data structure "Staff Member Identification Number"	Barcode	Staff Member ID	Barcode content	Barcode exists in memory
Barcodes of data structure "Donation Identification Number"	Barcode	Barcode number (1-12)	Barcode content	One row for each barcode set (0 to 12 rows)
Used program (only Spincontrol S from Version number > 050)	Program			Always
		Program number	Program name	Existing program used
			Program name Changed during run	Existing program used, but it was changed during run
		- empty column -	RAPID_TEMP	RAPID_TEMP used

V 2. 3

SERIAL CONTROL INTERFACE SPECIFICATION



Item	1 st column	2 nd column	3 rd column	Condition
			RAPID_TEMP Changed during run	RAPID_TEMP used, but it was changed during run
			--	No program used
Status	Status of run			Always
		Completed		Run finished already
		Not started		Spin did not start
		Still running		Still running
			Interrupted by error xy	Error during run
			Speed was partly out of setting	Speed error detected by run observation
			Stopped by user	Stop button pressed or shortrun
			Not started	Spin did not start
			Temperature not reached (yet)	Set temperature (still) not reached (only Spincontrol S)
				OK
Blank line				Always
Start Time	Start time of last run			Always
		abcd hours, ef minutes, gh seconds ago		Output depends on time since start
			OK	Spin did start
			Not started	Spin did not start
Kind	Kind of last run			Always
		Short run		Short run
		Normal run		Normal run
			Not started	Spin did not start
			OK	Always
Total Time	Total time			Only if started and finished already
		abcd hours, ef minutes, gh seconds		Output depends on total time
			Interrupted	Stop button pressed or shortrun
			OK	Run OK
Run Time	Run time			Only if normal run started
		Infinite		Run time set to infinite
		abcd hours, ef minutes, gh seconds		Output depends on set run time
			Interrupted	Stop button pressed or error happened
			Changed during run	Parameter was changed during run
			Still running	Still spinning
			OK	Run time OK
Runtime as of Set Speed	Runtime as of set speed	Active		Only if normal run started and Item was used
			Changed during run	Item was changed during run

PAGE 11

11 Appendix

V 2.3

SERIAL CONTROL INTERFACE SPECIFICATION



Item	1 st column	2 nd column	3 rd column	Condition
Deceleration Time	Deceleration time		OK	Item OK
				Only if deceleration time was displayed on screen
		abcd hours, ef minutes, gh seconds		Output depends on deceleration time
			OK	Always
Speed	Speed			If started
		abcde 1/min		Depends on set speed
			Speed was partly out of setting	Speed error detected by run observation
			Not Reached	Set speed was not reached
			Not reached yet	Set speed still not reached
			Changed during run	Set speed was changed during run
			OK	Speed OK
RFC	RCF			If started
		abcde *g		Depends on set RCF
			Speed was partly out of setting	Speed error detected by run observation
			Not Reached	Set RCF was not reached
			Not reached yet	Set RCF still not reached
			Changed during run	Set RCF was changed during run
Temp	Temperature			Only models with Cooling/Heating if started
		-ab +/- 2 degree Celsius		Output depends on set temperature and set temperature unit
			Not Reached	Set temperature was not reached
			Not reached yet	Set temperature still not reached
			Changed during run	Set temperature was changed during run
Rotor	Rotor			Temperature OK
			OK	If started
Bucket	Bucket	abcde		Output depends on set rotor
			OK	Always
Acceleration	Acceleration			Only if started and a rotor with bucket is set
		abcde		Output depends on set bucket
			OK	Always
		Curve 9 (Short run)		If started
				Short run

V 2. 3

SERIAL CONTROL INTERFACE SPECIFICATION



Item	1 st column	2 nd column	3 rd column	Condition
		Curve x		Normal run, output depends on set acceleration curve
			Changed during run	Set acceleration curve was changed during run
			OK	Set acceleration curve unchanged
Deceleration	Brake			If started
		Curve 9 (Short run)		Short run
		Curve x (Quick stop)		Quick stop
		Curve x		Normal run, output depends on set deceleration curve
			Changed during run	Set deceleration curve was changed during run
			Still running	Still spinning
Spinout	Spinout			Only if normal run started and Item was used (not quick stop)
			From abcd 1/min	Output depends on set Spin out speed
			Changed during run	Item was changed during run
			Still running	Still spinning
			OK	Item OK
Integral	Integral	abcxyz	OK	Output (abcxyz) depends on integral (only Spincontrol S)

The columns are separated by semicolon.

11 Appendix

V 2. 3

SERIAL CONTROL INTERFACE SPECIFICATION



4.3.3 Commands related to programs

setpara This command sets all necessary parameters for a centrifugation at once. Because it's implemented to enable scanning all the centrifugation parameters using a 1D barcode scanner, its command parameters are NOT separated by colons as usual (Code128 has max. data length of 48 characters). Therefore setting up the command parameters has to follow this specification strictly, to guaranty setting the centrifugation parameters correctly.

Parameter number	Meaning	Accepted values
1 to 5	Rotor	Only rotors listed in the centrifuges rotor menu are accepted. 5 characters are mandatory, so fill up rotor number with leading zeros if necessary!
6 to 10	Bucket	Only buckets listed in the centrifuges rotor menu are accepted, but only if they fit to the rotor sent in 1 to 5. 5 characters are mandatory, so fill up bucket number with leading zeros if necessary! If a rotor without buckets is used, set to '00000'.
11 to 13	Radius in mm	'000' (=Rmax) and all values from Rmin to Rmax 3 characters are mandatory, so fill up radius with leading zeros if necessary!
14 to 16	Density in g/cm ³ * 10	'012' to '100' (=1.2g/cm ³ to 10.0g/cm ³) 3 characters are mandatory, so fill up density with leading zeros if necessary!
17	's' for speed, 'r' for RCF	's', 'S', 'r', 'R'
18 to 22	Speed or RCF	Speed: '00100' to maximum speed of rotor and density RCF: Minimum to maximum RCF of rotor and radius 5 characters are mandatory, so fill up speed/RCF with leading zeros if necessary!
23	Sign for temperature value	+', '-' (only centrifuges with cooling/heating, ignored else)
24 to 25	Temperature value	Minimum temperature of centrifuge to maximum temperature of rotor (only centrifuges with cooling/heating, ignored else). 2 characters are mandatory, so fill up temperature with leading zeros if necessary!
26 to 31	Run time in seconds	'000000' (infinite run) and '000010' to '359999' 6 characters are mandatory, so fill up time with leading zeros if necessary!
32 to 33	Acceleration curve	'00' to '19' (always) plus '20' to '29' (but only if the corresponding curve is stored in centrifuge). 2 characters are mandatory, so fill up curve number with leading zero if necessary!
34 to 35	Deceleration curve	'00' to '19' (always) plus '20' to '29' (but only if the corresponding curve is stored in centrifuge). 2 characters are mandatory, so fill up curve number with leading zero if necessary!
36 to 37	Spin-out speed * 100rpm	'00' (no spin-out), '01' to '10' (=spin-out speed from 100rpm to 1000rpm). 2 characters are mandatory, so fill up with leading zero if necessary!
38	Flag "runtime as of set speed"	'0', '1'

Due to this, the parameter length is fixed to 38, so the whole command takes 46 characters. If the length is not exactly 46 characters, the command will be ignored.
This command is only available for Spincontrol S.

4.3.4 Other commands

getname Displays name of the centrifuge (given by centrifuge menu Setup System Name).

getprocess This command gives an overview about the currently set process data (rotor number, bucket number, spd in rpm, time in seconds – 0 is endless, temperature in °C [only centrifuges with cooling/heating], acceleration curve number, deceleration curve number) as well as information about rotor spinning (run = 1) or not (run = 0) and if an error appeared (err = 1) or not (err = 0). It also contains a crc (xor all data) to enable check of correct transmission.

```
getprocess
rotor,bucket,spd,time,temp,acc,dec, run, err,crc
11805, 13850, 200, 0, 20, 9, 29, 0, 0, 207
```

4.4 Additional commands of Spincontrol S

getpara This command returns all necessary parameters for a centrifugation at once. It's implemented to enable copying a parameter setting into another centrifuge (in combination with "setpara"). Therefore output is in the same format as expected by command "setpara".
This command is only available for Spincontrol S.

setprog This command is to store the actual centrifugation parameters to a program with the given number and name. Therefore, two parameters are mandatory, separated by comma. First parameter specifies the program number, valid from 1 to 60.
Attention: already stored program on this position will be overwritten!
The second parameter is a string with at least one, but up to 19 ASCII characters and specifies the program name.
This command is only available for Spincontrol S.

getprog This command returns set program number (1 to 60) and program name. It's implemented to copy programs at the same position with the same name on another centrifuge. Therefore output is in the same format as expected by command "setprog". If no program is set, output is "0,-", if RapidTemp is set, output is "0,RapidTemp".
This command is only available for Spincontrol S.

getlibr This command returns all stored user programs, one program per line in format program number (1 to 60), comma, program name, comma and program parameters as returned by command getpara. It's implemented to copy all programs at the same position with the same name and same parameters on another centrifuge. But a corresponding "setlibr" function is not implemented yet.
This command is only available for Spincontrol S.

loadprog This command loads a program of the centrifuge. It's only accepted if no centrifugation is in progress.
One parameter is mandatory and specifies the program to load, where valid programs are:
- 0 (only for centrifuges with refrigerator/heater) = RapidTemp program.
Command is only accepted if
→ set temperature is below actual temperature (centrifuge with refrigerator only)
→ set temperature is above actual temperature (centrifuge with heater only)
→ set temperature is different to actual temperature (centrifuge with refrigerator and heater)
→ never (centrifuge without refrigerator or heater)
- 1 to 60 = corresponding program stored in centrifuge.
Command is not accepted if the program doesn't exist.
This command is only available for Spincontrol S.

11 Appendix

V 2. 3

SERIAL CONTROL INTERFACE SPECIFICATION



- setbarcode** This command adds one barcode (Code128 = ISBT128) to the next centrifugation run. It's possible to add up to 13 barcodes to one run (12 codes of data structure "Donation Identification Number" from blood bags plus 1 code of data structure "Staff Member Identification Number"). The syntax is "setbarcode abc" where abc = content of the barcode. The content of the barcodes is not verified in any matter, only the kind of data structure is checked. Each barcode has to be set separately.
This command is accepted only if
- no centrifugation is in progress and
 - there are no barcodes from an older run in memory (use "deletebarcodes" command to delete them) and
 - Barcode is of data structure "Donation Identification Number" or "Staff Member Identification Number" and
 - same barcode is not already stored and
 - less than 12 barcodes of data structure "Donation Identification Number" are set already if it's a barcode of data structure "Donation Identification Number" and
 - No barcode of data structure "Staff Member Identification Number" is set already if it's a barcode of data structure "Staff Member Identification Number".
- Using this command will also delete all memorized data of the last run (see getlastrun command) to inhibit invalid combination of barcodes with old run data.
If barcode menu is implemented in the centrifuge software, it will come up and display the stored barcodes.
This command is only available for Spincontrol S.
- getbarcodes** This command is always accepted and triggers output of existing barcodes in memory as follows:
"Barcodes abc, def, ghi, ..."
where abc = content of first barcode, def = content of second barcode, ghi = content of third barcode and so on for one up to 12 barcodes of data structure "Donation Identification Number".
If a barcode of data structure "Staff Member Identification Number" is stored, it's output as first barcode with the extension (staff), so output is
"Barcodes abc (staff), def, ghi, ..."
If no barcode is stored, output is
"Barcodes none"
This command is only available for Spincontrol S.
- deletebarcodes** This command deletes all existing barcodes from memory. It's only accepted (even if no barcodes are stored) if no centrifugation is in progress.
If barcode menu is just on display, it will be updated.
This command is only available for Spincontrol S.
- probar** This command returns the status of the displayed Progress Bar. It's intended for use by DataSuite, which displays the actual progress on a PC. It's answer has 2 parameters:
- parameter 1 corresponds to the displayed progress in per cent in decimal,
 - parameter 2 is in hex with following meaning,
 - bits 0-7 are equal to answer to command "getstatus1",
 - bit 8 signals that ProBar is **not** on display,
 - bit 9 signals that ProBar on display is **blinking**.
 - bit 10 signals that set speed/RCF is reached
 - bit 11 signals that set temperature is reached (only centrifuges with temperature control)
- This command is only available for Spincontrol S.

4.5 Commands of centrifuges for robot placement

run n Starts the centrifuge with speed n [rpm].

Note: If the centrifuge is equipped with a hatch in the lid, this command closes the hatch and the centrifuge begins to start the run when the hatch is closed.
If the centrifuge is equipped with a bucket lifter unit, the bucket is moved to its lowest position before the run starts.

PAGE 16

4.5.1 Commands for control panel

- lock** Lock buttons and navigation on control unit (control possible via RS232 only)
- unlock** Unlock buttons and navigation on control unit

4.5.2 Commands for motor driven lid or hatch

- close** closes the lid / hatch
- door** opens the lid / hatch

4.5.3 Commands for rotor positioning

- setpos n** n=0: unlock the rotor
n>0: go to position n
the lid must be close for positioning

Note: If the centrifuge is running, this command stops the run automatically and the rotor goes to position n. If the centrifuge is equipped with a hatch in the lid, the hatch opens automatically during positioning. If the centrifuge is equipped with a bucket lifter unit, the bucket is moved to its lowest position before positioning starts.

- pos** Outputs the position of the rotor in positioning mode

4.5.4 Commands for bucket lifter unit

- lift** move the bucket to its upper end position

Note: The command is not accepted while the rotor is spinning during run or positioning.

- release** move the bucket to its lower end position

4.5.5 Commands for Rotor Cycle Counter

An additional rotor cycle counter is implemented for free use by the user. This counter can only be read out by serial interface. The maximum count value is 4294967295. The value will be set to 0 in case of overflow.

- rcycle** Displays the current rotor cycle counter.
- bcycle** Displays the current bucket cycle counter. ONLY Spincontrol L
- erasercycle** Resets the rotor cycle counter to "0". ONLY Spincontrol Universal

11 Appendix

V 2.3

SERIAL CONTROL INTERFACE SPECIFICATION



4.5.6 Commands for Servo Cycle Counters

liftercycles get cycles of bucket lifter unit
lockcycles get cycles of rotor lock unit
slidercycles get cycles of slider unit

4.6 Table of user commands

The following table contains the available user commands.

Command name	2. name	Parameters	Return values	Unit	Format ¹	Only models with
?	??		list of commands		ASCII	
bcycle			1	cycles	UINT	Robot placement
close						Robot placement
cmderror			1	0..1	UINT	
curr			4	rpm, °C, status, status1	UINT, INT, UINT, HEX	
deletebarcodes						Spincontrol S
door						
echooff				ch. 4.2.9		
echoon				ch. 4.2.9		
erasercycle						Robot placement and Spincontrol Universal
fstop						
getaccel	IN_PAR_1		1	acc. curve nr	UINT	
getbarcodes			ch. 0	Barcodes	ASCII	Spincontrol S
getcurve		1	ch. 4.3.1	ch. 4.3.1	ch. 4.3.1	Spincontrol Professional, S
getcurvelist			list	see ch. 4.2.9	see ch. 4.2.9	optional
getdecel	IN_PAR_2		1	dec. curve nr	UINT	
geterr	syserror		1 or 4	error	UINT	
geterrpara			list		ASCII	Except Spincontrol Professional, S
getlastrun			ch. 4.3.2	ch. 4.3.2	ch. 4.3.2	Spincontrol Professional, S
getlibr			see ch. 4.3.3	see ch. 4.3.3	see ch. 4.3.3	Spincontrol S V051
getname			1	Name	ASCII	Spincontrol Professional, S
getpara			1	see ch. 4.3.3	see ch. 4.3.3	Spincontrol S V051
getprocess			10	see ch. 4.3.4	see ch. 4.3.4	Spincontrol Professional, S
getprog			2	see ch 4.3.3	see ch 4.3.3	Spincontrol S V051
getrotor			1	Rotor List Index	UINT	
getrotorlist			list	see ch. 4.2.9	see ch. 4.2.9	optional
getsetspeed	IN_SP_1		1	rpm	UINT	

11 Appendix

V 2. 3

SERIAL CONTROL INTERFACE SPECIFICATION



Command name	2. name	Parameters	Return values	Unit	Format ¹	Only models with
getsettemp	IN_SP_2		1	°C	INT	Temperature control
getsettime	IN_SP_3		1	sec.	UINT	
info			list	ch. 4.2.9		
lift						Bucket lifter unit
liftercycles			1	cycles	UINT	Bucket lifter unit
loadprog		1		Program number	UINT	Spincontrol Professional, S
lock						Robot placement
lockcycles			1	cycles	UINT	Bucket lifter unit
pos			1	1.4	UINT	Robot placement
probar			2	%, flags	UINT, HEX	Spincontrol S
rcycle			1	cycles	UINT	Robot placement
release						Bucket lifter unit
reset						
reseterr						
run		1		rpm	UINT	Robot placement
setaccel	OUT_PAR_1	1		acc. curve nr	UINT	
setbarcode		1		Barcode	ASCII	Spincontrol S
setcurve		ch. 4.3.1	ch. 4.3.1	ch. 4.3.1	ch. 4.3.1	Spincontrol Professional, S
setdecel	OUT_PAR_2	1		dec. curve nr	UINT	
setpara		1		see ch. 4.3.3	see ch. 4.3.3	Spincontrol Professional, S
setpos		1		1.4	UINT	Robot placement
setprog		2		see ch. 4.3.3	see ch. 4.3.3	Spincontrol Professional, S
setrotor		1		Rotor List Index	UINT	
setspeed	OUT_SP_1	1		rpm	UINT	
settemp	OUT_SP_2	1		°C	INT	Temperature control
settime	OUT_SP_3	1		sec.	UINT	
slidercycles			1	cycles	UINT	Bucket lifter unit
speed	IN_PV_1		1	rpm	UINT	
start						
status			1	ch. 4.2.8	UINT	
status1			1	ch. 4.2.8	HEX	
status2			1	ch. 4.2.8	HEX	Robot placement
stop						
temp	IN_PV_2		1	°C	INT	Temperature control
time	IN_PV_3		1	sec.	UINT	

PAGE 20

V 2.3

SERIAL CONTROL INTERFACE SPECIFICATION



Command name	2. name	Parameters	Return values	Unit	Format ¹	Only models with
unlock						Robot placement

¹ UINT = decimal unsigned integer value; INT = decimal signed integer value; HEX = hexadecimal value

11 Appendix

V 2.3

SERIAL CONTROL INTERFACE SPECIFICATION



5 Examples

Note: All commands have to be send without quotation marks and brackets!

[CR] and [LF] are ASCII coded control characters (Carriage Return and Linefeed)

setting the setspeed to 1000 rpm:

```
`setspeed 1000[CR][LF]'
```

starting the centrifuge:

```
`start[CR][LF]'
```

requesting the actual rotorspeed:

```
`speed[CR][LF]' answerstring: `1000[CR][LF]'
```

running the centrifuge at 2000 RPM for 2 minutes. Temperature: 5°C:

```
`setspeed 2000[CR][LF]'
```

```
`settemp 5[CR][LF]'
```

```
`settime 120[CR][LF]'
```

```
`start[CR][LF]'
```

requesting the actual status of the centrifuge:

```
`status[CR][LF]' answer string: `0[CR][LF]' (rotor is spinning)
```

or: `1[CR][LF]' (rotor is stationary)

requesting all actual values of the centrifuge:

```
`curr[CR][LF]' answerstring: `speed temp status status1[CR][LF]
                               2000 5 1 0004[CR][LF]'
```

to request the actual parameters periodically you have to put a '/tn' behind the command. The 'n' stands for the repeat rate in seconds. Entering a '.' stops monitoring.

requesting the actual values of the centrifuge periodically every 5 seconds:

```
command: `curr /t5[CR][LF]'
```

```
answer of the centrifuge: `speed temp status status1[CR][LF]
                          2000 5 1 0004[CR][LF]
```

```
5 seconds later: 2001 5 1 0004[CR][LF]
```

Stop requesting the actual values of the centrifuge periodically:

```
command: `curr /t.[CR][LF]'
```

6 Hardware interface (optional accessory)

6.1 Pinning of the connector

Pinning of the 9 pin SUB-D (male) connector on the cover of the centrifuge

PIN 2: TxD (transmit)
 PIN 3: RxD (receive)
 PIN 5: GND (ground)
 PIN 1,4,6,7,8,9: Not Connected

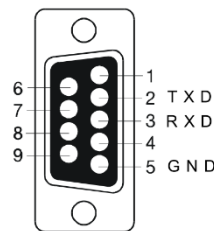

6.2 Typical connection to a PC

Typical connection to a personal computer or a terminal with serial RS232 interface:

9-pin male socket at PC / terminal:

Standard 1:1 serial cable (9 pin female ⇔ 9 pin female)

Required: PIN 2 ⇔ PIN 2 TxD (Cent.) ⇔ RxD (PC)
 PIN 3 ⇔ PIN 3 RxD (Cent.) ⇔ TxD (PC)
 PIN 5 ⇔ PIN 5 GND (Cent.) ⇔ GND (PC)

25-pin male socket at PC / terminal:

Standard 1:1 serial cable (9 pin female ⇔ 9 pin female) + 9-25 way Adaptor, 9 pin male ⇔ 25 pin female

or

Serial cable (9 pin female ⇔ 25 pin female):

Pin-Pin Configuration (only boldface printed required):

D Sub 9 : 1 **2 3** 4 **5** 6 7 8 9
 D Sub 25: 8 **3 2** 20 **7** 6 4 5 22

Note: Do not use a "Null-Modem" cable/adaptor with crossed RxD/TxD signals

11 Appendix

V 2. 3

SERIAL CONTROL INTERFACE SPECIFICATION



7 History

Autor	Datum	Version	Änderungen
D. Hanke	07.11.2008	0.1	Initial Version
D. Hanke	11.11.2008	0.2	status2 and geterr added
D. Hanke	22.02.2010	0.3	Add chapters 5.1 – 5.3
Ch. Seydel	13.12.2010	0.4	Add getname
Ch. Seydel	25.03.2011	0.5	Add bicycle, remove erasercycle
Ch. Seydel	05.03.2012	0.6	Add getlastrun, Spincontrol L and spincontrol S
Ch. Seydel	02.05.2012	0.7	Add Centrifuge ID to getlastrun command
Ch. Seydel	27.05.2012	0.8	Change answer to getlastrun command: - Change order: 1) Centrifuge name 2) Status of run 3) Blank line - Delete Radius and Density
Ch. Seydel	15.10.2012	0.9	Add Barcode commands and add Barcodes to getlastrun command
Ch. Seydel	28.03.2013	1.0	reseterr command limited to reset only errors of type "Log" and "Warning"
Ch. Seydel	06.12.2013	1.1	- update "setbarcode"-, "getbarcodes"-, "deletebarcodes"- and "getlastrun"-commands - add "loadprog" - add the prompt to chapter 4 Communication protocol
Ch. Seydel	20.01.2014	1.2	- add commands "setpara" and "setprog" to chapter 4.9 - getlastrun output strings for "Runtime as of set speed" and "Quick stop" changed to same string used in GUI
Ch. Seydel	03.02.2014	1.3	changed "Break time" to "Deceleration time" in "getlastrun" command
Ch. Seydel	27.08.2014	1.4	- add chapter 4.5.4 Commands for bucket lifter unit - add bucket position to status2 command

PAGE 24

V 2.3

SERIAL CONTROL INTERFACE SPECIFICATION



Autor	Datum	Version	Änderungen
Ch. Seydel	27.08.2014	1.5	<ul style="list-style-type: none"> - add lock and unlock commands to chapter 5.2 Commands for centrifuges with rotor positioning - add door command to chapter 5.1 Commands for centrifuges with motor driven lid or hatch and exception to door command at chapter 4.3 Control commands - add getprocess command for Spincontrol S and Professional - add chapter 4.1 Reset message
Ch. Seydel	29.09.2014	1.6	OK-Return message to "echoon" changed into capital letters (was Ok before)
Ch. Seydel	30.04.2015	1.7	Add hint "(only centrifuges with cooling/heating)" to commands settemp, temp, getsettemp and to corresponding parameters of commands curr, setpara, getprocess
Ch. Seydel	04.05.2015	1.8	Add comment "only set while centrifuge breaks" to bit5 of status1
Ch. Seydel	28.09.2015	1.9	<ul style="list-style-type: none"> - update "getlastrun" - add "geterrpara" - add "liftercycles", "slidercycles", "lockcycles" - update "geterr" 90/93/95 - add CYCLES to return messages - re-arrange chapters
D. Hanke	03.12.2015	2.0	<ul style="list-style-type: none"> - add "getrotor", "setrotor" - add "getcurvelist", "getrotorlist"
Ch. Seydel	14.12.2015	2.1	Add getpara, getprog and getlibr
Ch. Seydel	12.10.2016	2.2	<ul style="list-style-type: none"> - add "Temperature not reached (yet)" to 3rd column of "Status of run" entry of getlastrun data - add "Integral" entry to getlastrun data - add command "probar" - move commands which are for Spincontrol S only to chapter 4.4 Additional commands of Spincontrol S
Ch. Seydel	07.02.2017	2.3	Add b10 and b11 to command "probar"

11 Appendix

11.7 EC declaration of conformity



EC – DECLARATION OF CONFORMITY

The product named hereinafter was developed, designed, and manufactured in compliance with the relevant, fundamental safety and health requirements of the listed EC directives and norms.

In the event of modifications that were not authorised by us or if the product is used in a manner that is not in line with the intended purpose, this declaration will be rendered void.

<i>Product name:</i>	Laboratory centrifuge
<i>Product type:</i>	Sigma 4-5KRL
<i>Order number:</i>	91309, 91564
<i>Directives:</i>	2006/42/EC Machinery Directive 2014/35/EU Low Voltage Directive 2014/30/EU EMC Directive (EU) 2015/863 RoHS Directive
<i>Normes:</i>	EN 61010-2-020:2017 EN 61010-2-011:2017 EN IEC 61000-3-2:2019 EN 61000-3-3:2013 EN 61326-1:2013

Sigma Laborzentrifugen GmbH

An der Unteren Söse 50
37520 Osterode
Germany

Authorised representative
for CE matters:
Eckhard Tödteberg

Osterode, 07/04/2020



General Manager

11 Appendix



EC – DECLARATION OF CONFORMITY

The product named hereinafter was developed, designed, and manufactured in compliance with the relevant, fundamental safety and health requirements of the listed EC directives and norms.

In the event of modifications that were not authorised by us or if the product is used in a manner that is not in line with the intended purpose, this declaration will be rendered void.

<i>Product name:</i>	Laboratory centrifuge
<i>Product type:</i>	Sigma 4-5KRL IVD
<i>Order number:</i>	100008, 100009
<i>Directives:</i>	98/79/EC In vitro Diagnostica (EU) 2015/863 RoHS Directive
<i>Normes:</i>	EN 61010-2-101:2017 EN 61010-2-020:2017 EN 61010-2-011:2017 EN IEC 61000-3-2:2019 EN 61000-3-3:2013 EN 61326-1:2013

Sigma Laborzentrifugen GmbH

An der Unteren Söse 50
37520 Osterode
Germany

Authorised representative
for CE matters:
Eckhard Tödteberg

Osterode, 07/04/2020



General Manager

11 Appendix

11.8 Declaration of conformity – China RoHS 2



DECLARATION OF CONFORMITY

China RoHS 2 (Administrative Measures for the Restriction of the Use of Hazardous Substances in Electrical and Electronic Products)

Laboratory centrifuge models: Sigma 1-14, 1-14K, 1-7, 1-16, 1-16K, 2-7, 2-16P, 2-16KL, 2-16KHL, 3-16L, 3-16KL, 3-18KS, 3-18KHS, 3-30KS, 3-30KHS, 4-5L, 4-5KRL, 4-16S, 4-16KS, 4-16KHS, 4-16KRL, 6-16S, 6-16HS, 6-16KS, 6-16KHS, 6-16KRL, 8KS, 8KBS

Sigma Laborzentrifugen GmbH has made reasonable effort to avoid the use of hazardous substances in the products it manufactures (laboratory centrifuges).

A Product Conformity Assessment (PCA) was performed in order to determine whether the concentration of harmful substances in all homogeneous materials of the component parts is above or below the MCV limit (Maximum Concentration Value limit) as defined in GB/T 26572:

Mercury and its compounds: 0.1 % Cadmium (Cd) and its compounds: 0.01 %
 Lead (Pb) and its compounds: 0.1 % Hexavalent chromium (Cr (VI)) and its compounds: 0.1 %
 Polybrominated biphenyls (PBB): 0.1 % Polybrominated diphenyl ethers (PBDE): 0.1 %

表1 产品中有害物质的名称及含量
 Table 1: Name and content of hazardous substances in the product

部件名称 Component part (PCA)	有害物质 Hazardous substance					
	铅 Lead (Pb)	汞 Mercury (Hg)	镉 Cadmium (Cd)	六价铬 Hexavalent Chromium (Cr (VI))	多溴联苯 Poly-brominated biphenyls (PBB)	多溴二苯醚 Polybrominated diphenyl ethers (PBDE)
Electronic PCB, cables	X ¹⁾	○	○	○	○	○
Display	○	○	○	○	○	○
Housing	X ²⁾	○	○	○	○	○
Base, metal, accessories	X ²⁾	○	○	○	○	○

本表格依据SJ/T 11364的规定编制。
 This table is made according to SJ/T 11364.

11 Appendix



O: 表示该有害物质在该部件所有均质材料中的含量均在GB/T 26572规定的限量要求以下。
Indicates that the content of the harmful substance in all homogeneous materials of the component part is below the limit as defined in GB/T 26572.)

X: 表示该有害物质至少在该部件的某一均质材料中的含量超出GB/T 26572规定的限量要求。(企业可在此处, 根据实际情况对上表打“X”的技术原因进行进一步说明。)
Indicates that the content of the harmful substance in at least one homogeneous material of the component part exceeds the limit as defined in GB/T 26752. (Contact the manufacturer for further technical information according to the actual situation.)

1) Contains parts in compliance with exemptions 6c, 7c.I, 7c.II and 37 of 2011/65/EU RoHS.

2) Contains parts in compliance with exemptions 6a, 6b and 6c of 2011/65/EU RoHS.

Apart from the exemptions given in this table, none of the substances listed above have been intentionally added to the product or metallic coatings.

Sigma Laborzentrifugen GmbH

An der Unteren Söse 50
37520 Osterode
Germany

Osterode, 20/11/2017



General Manager

12 Index

A	
Acceleration	41
Acceleration curves.....	41, 66
Accessories, cleaning and care.....	53
Acid.....	22, 52, 54
Acoustic signal.....	48
Activating the modification mode.....	35
Adapters	33, 53
Alkaline solutions	22, 52, 54
Ambient conditions.....	63
Ambient temperature	63
Anodised coating	53
Application examples	15
Autoclaving	57
B	
Brake	41
Brief mains power failure.....	48
Bucket.....	33
Buckets, cleaning and care	54
C	
Cable RS232	10
Capacity.....	62
Carrier.....	33
Carrier systems.....	33
Carriers, cleaning and care	54
CE mark in compliance with the directive 2006/42/EC	17
Centrifugation of infectious, toxic, radioactive, or pathogenic substances.....	21
Centrifugation principle	15
Centrifugation with low capacity	32
Centrifugation with vessels of various sizes	32
Centrifuge cannot be started.....	48
Centrifuge decelerates during operation	48
Centrifuge is inclined.....	48
Centrifuge lid.....	11
Centrifuge was moved during run	48
Centrifuge, cleaning and care	52
Changes in colour.....	57
Changes in structure.....	57
Check commands	46
Chemical and biological safety.....	21
Chemical resistance of plastic.....	54
China RoHS 2 – Declaration of conformity	103
Cleaning agents	56
Cleaning the bores of angle rotors	53
Cleaning the centrifuge	52
Closing the lid	20, 30
CO ₂ equivalent.....	62
Communication error	50
Condensation.....	28
Condenser dirty	48
Condenser, cleaning and care	53
Connection.....	45
Contamination.....	21, 53
Continuous heat resistance.....	56
Continuous run	37
Control system.....	34
Copyright	10
Corrosion	20, 23, 33, 52, 53, 54, 56
Cost estimate.....	59
Cracking	53
Cracks	54
Customer-provided fuses	29
Cycle display (Cycles).....	42
Cycles (cycle display)	42
D	
Damage of the surface.....	54
Dangerous goods.....	22
Dangerous materials.....	56
Date of manufacture	13
Deceleration curves	41, 66
Declaration of conformity	10, 99
Declaration of conformity – China RoHS	2103
Declaration of decontamination.....	59, 61
Decontamination agent.....	53, 56
Deformation of tubes.....	57
Density.....	13, 22
Different service life of rotors and accessories	23, 67
Dimensions	26

Index

Direct hazard to the life and health.....	18	I	
Directive 2002/96/EC	61	Imbalance	31, 33
Disinfectants	56	Imbalance error.....	50
Disinfection of the rotor chamber and accessories	56	Imbalance monitoring system	24
Display	34	Importance of the operating manual.....	9
Disposal of the centrifuge.....	61	Important information	18
Disposal of the packaging	61	Improper loading.....	48
Documentation.....	10	Infectious substances	56
Drive problem	48	Inflammable substances	21
E		Informal safety instructions	19
Earth conductor check	24	Initial start-up	30
EC declaration of conformity	10, 99	Input.....	46
EEPROM error.....	50	input commands	46
Electrical connection	62	Input fuse	62
Electrical safety.....	20	Input lock	43
Emergency lid release	49	Input values	46
Equipotential bonding screw	24	Inspection by the manufacturer	58
Error correction	48	Installation of accessories	31
Error message	48	Installation of rotors and accessories	31
Explanation of the symbols and notes.....	18	Installation of the rotor	31
Explosive substances	21	Installation site	28
F		Insufficiently greased load-bearing bolts ...	55
Filling quantity (refrigerant)	62	Intended use	9
Fire preventions	21	Interrupting a centrifugation run	35
Form for the return of defective parts	59	Interrupting a deceleration process	35
Freezing-over of the compressor	38	IP code	62
Functional and operating elements	11	K	
Fuses have tripped	48	Kinetic energy	13, 62
G		L	
General conditions	9	Layout of the centrifuge.....	11
Glass breakage.....	56	Leaks	57
Glass particles	56	Lid cannot be opened	48
Gravitational field	62	Lid error	50
Grease for load-bearing bolts.....	10, 52, 55	Lid lock device	24
H		Lid lock has not released	48
Hard running noise during the centrifugation	48	Lid seal sticks	48
Hazard warnings.....	9, 31, 33	light barriers	21
Heavy-duty grease for load-bearing bolts.....	10, 55	Linear curves	66
Hexagon socket wrench.....	10	Loading a program.....	44
Highly corrosive substances	20	M	
		Mains power switch.....	49
		Mains power switch off.....	48
		Mains switch	11
		Mains voltage.....	20

Maintenance	52	Pressure (refrigerant)	62
Malfunctions and error correction	48	Pressure marks	54
Manual mode	35	Prevention of accidents	9
Manufacturer	62	Problem description	59
Marking of the unit	17	Process error	50
Maximum number of cycles	42	Process values	46
Measures in the event of hazards and accidents	25	ProgLock program lock	41
Mechanical safety	20	Program "Rapid Temp"	39
Mode of operation	15	Program lock (ProgLock)	41
Motor error	50	Protection class	28, 62
Motor shaft	31, 52	Q	
Multiple carrier	33	Quick stop	35
N		Quitting the modification mode	35
Name plate	11, 13	R	
No indication on the display	48	Radioactive substances	21, 52
No power in the mains supply	48	Radius	16
Noise level	62	Rapid Temp program	39
Nominal voltage	13	Reaching the maximum number of cycles ..	42
Notes on safety and hazards	9	Refrigerant	62
Notes on transport	26	Refrigerant data	13, 62
O		Relative centrifugal force (RCF)	16, 36
Online download of forms	60	Removal of a rotor	31
Opening the lid	30	Removal of the transport safety device	27
Operating personnel	19	Remove glass particles and metal dust from the rotor chamber	56
Operating voltage	28	Responsibility of the operator	19
Operational safety	53	Return of centrifuges, spare parts, or accessories	59
Overseas shipping	26	Return of defective parts	59
P		Risk of electrical shock	20
Packaging	27	robot-controlled centrifuge	45
Parameter error	50	Rotor chamber	38, 52
Part number	62	Rotor monitoring system	24
Pathogenic substances	21, 52, 56	Rotor radii	64
Plastic accessories, cleaning and care	54	Rotor selection	40
Position of the opening for the emergency lid release	49	Rotor tie-down screw	31, 54
Positioning of the rotor	46	Rotor wrench	10, 31
Potential hazard to the life and health	18	Rotors	45
Potentially hazardous situation	18	Rotors and accessories with a different service life	23, 67
Power consumption	13, 62	Rotors for microtiter plate formats	31
Power cord is not plugged in	48	Rotors, cleaning and care	54
Power failure	49	RS232 cable	10
Power supply	28	Runtime	36
Preselection of a curve	41	Runtime as of the set speed	37

Index

S	
Safety area	22
Safety devices	24
Safety distance	20, 22, 28
Safety instructions.....	9, 31, 33
Safety Instructions for automated centrifuges	21
Safety instructions for centrifugation	22
Safety of rotors and accessories	23
Safety, chemical and biological	21
Safety, electrical	20
Safety, mechanical.....	20
Safety-conscious work	19
Saving a program.....	44
Scope of supply	10
Screws of the transport safety device are not removed	48
Selection, display, and modification of data	35
Serial number	13, 51, 58
Service.....	58
Service contact	51
Service life	52
Service life of rotors and accessories...	23, 67
Service life of the accessories.....	57
Service work	58
Set-up and connection	28
Short run.....	38
Slide cover	11
Solvents.....	22, 52, 54
Spare part enquiries.....	51
Speed	13, 16, 36, 62
Speed-gravitational-field-diagram	65
Speedometer error.....	50
Standards and regulations	10
Standstill monitoring system	24
Starting a centrifugation run	35
Status of the centrifuge	46
Sterilisation of the rotor chamber and accessories	56
Stopping of the centrifuge due to an imbalance.....	55
Storage and transport	26
Storage conditions	26
Storage locations	62
Stress-corrosion	
see	
corrosion	54
Structural changes.....	21
Suitable accessories	64
Suitable accessories	31
Supply voltage	28
Switching the centrifuge off	47
Switching the centrifuge on	30
System check	24
System error	48, 50
T	
Table of error codes.....	50
Table of rotors and accessories with a different service life	23, 67
Technical data	62
Technical documentation	63
Temperature error.....	50
Temperature inside the rotor chamber	24
Temperature monitoring system.....	24
Temperature range	62
Temperature value not reached	48
Thermal stress	52
Time range.....	62
Toxic substances	21, 52
Transport safety device.....	26, 27
Type.....	13, 62
Type of connection.....	28
Type of the centrifuge	51, 58
U	
Ungreased load-bearing bolts	48
Useful volume	
- volume that is stated for the tube	33
User interface	34
UV radiation	28, 52
V	
Vents	28
Vessels	33
W	
Warranty and liability.....	9
Wear.....	58
Weight	26